

Since 1946

# WITTEK



## Golf Supply Specialists



WASHERS



DISPENSERS



PICKERS

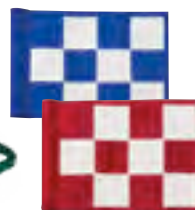

FLAGS



RECYCLED  
PLASTIC



SIGNS

2021

1-800-869-1800  
WITTEKGOLF.COM

Celebrating!  
**75**  
YEARS

## To Our Valued Customers and Friends:

As we write this letter entering Wittek's 75th year of business, we must first stop and thank each and every one of you for your trust in us throughout the years. Wittek has had unbelievable success in its 75 years, and we owe it all to each and every one of our valued customers and close friends. We are truly lucky to come to work each and every day, surrounded by an amazing team working around the clock to gain your trust with each and every order.

The past six years of our ownership have been nothing short of an incredible experience. When we acquired Wittek, we set out on a mission to take the highest quality course and range supplies to the next level. Throughout the years, we have made several acquisitions in order to serve you with better products, customer service and the best overall ordering experience in the industry. With \$5 million in inventory spread across three locations in the United States, everything you need for the season can be ordered both quickly and easily.

From pickers, washers, and dispensers, to recycled plastic and custom signage for your course and clubhouse, we make it all right here in the U.S.A. Our location in Georgia has the most skilled seamstresses in the industry working around the clock decorating the highest quality golf course flags, as well as custom apparel.

Just as you continue to invest in your property and people, we invest in ours. We're constantly making improvements in order to make more of the products you need, quicker and better than ever before. Again, we truly thank you for your continued business over the years and are looking forward to another exciting year in the world of golf!

Sincerely,  
Gene & Tim Pruban  
Wittek Golf

Hours: 7:00am – 7:00pm CST

800.869.1800

847.412.9591

info@wittekgolf.com

www.wittekgolf.com

Order Online 24 Hours a Day 7 Days a Week!

**WITTEK** Since 1946  
Golf Supply Specialists | 800-869-1800



Wittek Golf Supply

@WittekGolf

@Wittekgolfsupply

Wittek Golf Supply



## 2021 TABLE OF CONTENTS RANGE EQUIPMENT



**Ball Pickers 10-19**  
- A-Frames 18  
- Cart Adapters 18  
- Conversion Kits 18  
- Picker Baskets 10-19

**Ball Dispensers 23-25**  
- Payment Acceptors 24-25

**Ball Washers 20-22**  
- Soap 20

**Cart Protectors 18**

**Replacement Parts 10-17**  
- Full Parts List 166-169

## RANGE SUPPLIES



**Balls 33**  
**Ball Crates 30, 35**  
**Ball Popper 37**  
**Ball Stackers 44**  
**Bag Racks & Stands 38-41**  
**Bag Shags 36**  
**Bag Shag Tube 36**  
**Club Cleaners 42-43**  
**Hand Pickers 37**

**Mats 26-29**  
**Netting 57-59**  
**Pail Organizer 35**  
**Practice Nets & Cages 58-59**  
**Practice Stick 56**  
**Range Markings 44-55**  
**Range Bags 34**  
**Range Pails & Baskets 35**  
**Range Targets 48-55**

**Range Trays 29**  
**Range Woods 30**  
**Rubber Tees 31**  
**Sign Holders 56**  
**Starter Clocks 56**  
**Tee Dividers 45**  
**Yardage Markings 48-55**

## GOLF COURSE ACCESSORIES



**Adirondack Series 124**  
**Benches 121, 124-125**  
**Bunker Rakes 106-107**  
**Cape Cod Collection 123**  
**Coolers 118**  
**Cups 77, 79**  
**Cup Dispenser 118**  
**Custom Course Collection 127**  
**Divot Bottle Storage 110-112**  
**Divot Mix Storage 113**  
**Flags 60-73**  
**Flag Sticks 74-76**

**Heritage Collection 125**  
**Huntington Collection 122**  
**Signs 88-94**  
**Paper Cups 118**  
**Picnic Tables and more 126**  
**Podiums 120**  
**Practice Green Markers 79**  
**Putting Green Accessories 78**  
**Putting Green Flags 80-85**  
**Putting Green Flagsticks 79**  
**Reflectors 75**  
**Shoe Cleaning Station 98-99**

**Spike Cleaners 98-99**  
**Stakes & Rope 100-105**  
**Tee Consoles 134-135**  
**Tee & Information Signs 90**  
**Tee Markers 95-97**  
**Towels 135-136**  
**Tournament Accessories 149**  
**Trash Containers 114-117**  
**Water Stations 118-119**  
**Yardage Marker Systems 109**

## IRRIGATION & MAINTENANCE



**Hole Cutters 139-141**  
**Hoses 145**  
**Irrigation Attachments 145**  
**Maintenance Acc. 146-147**  
**Marking Paint 138**

**Marking Supplies 138**  
**Nozzles 145**  
**Pitchers 144**  
**Rakes 143**  
**Soil Surfactant Applicators 144**

**Suction Pumps 144**  
**Tournament Accessories 149**  
**Trimmers & Gages 142-143**

## PRO SHOP ACCESSORIES



**Ball Markers 152**  
**Custom Bag Tags 153**  
**Divot Tools 152**  
**Golf Cart Accessories 148**

**Golf Cart Towels 148**  
**Golf Grips 156-157**  
**Pencils 150,163**  
**Rental Clubs 154-155**

**Replacement Cleats 153**  
**Tees 151**

## MINI GOLF



**Balls 160-161**  
**Ball Vendor 163**  
**Grips 162**

**Putters 158-159**  
**Putter Holders 162**  
**Scorecards 163**

**Signs 165**  
**Tee Off Mats 164**  
**Turf 164**

Order online 24/7 @ [www.wittekgolf.com](http://www.wittekgolf.com)



## NEW PRODUCTS FOR THE RANGE

## ▶ OCTAGON MAT

Size: 5'  
Weight: 25 lbs.  
Pile Height .5"  
Backing 5/8" mm Foam  
#304F



See page #29

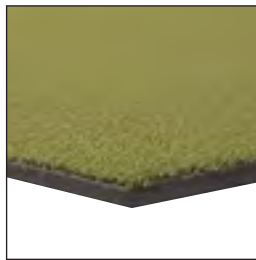
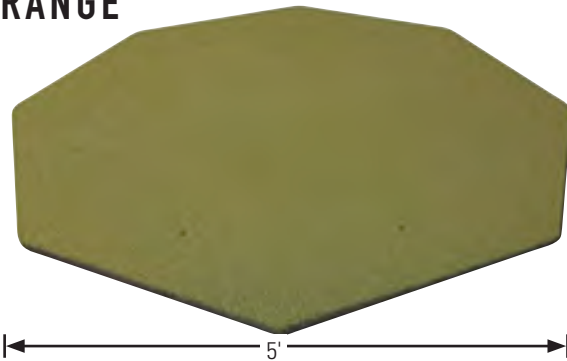

## ▶ MINI MAT

- Includes two tee holes for both left and right-handed use.
- 100% Woven Nylon
- Industrial bonded, exceeding industry standards for quality and durability.
- Weather resistant with ultra-violet protection.
- Resists tears, fading, curling, and separation.
- Mat is delivered rolled and can easily be rolled up and stored away!
- Easy to carry and store.
- Indoor / Outdoor use.

Size: 3'W x 5'L Weight: 11 lbs.  
Pile Height .5"  
Backing 5mm Foam  
#304D



See page #29

## ▶ THE TOUGHLIE SHORT GAME UNIT

Increased interest in practice - More engaged students means more lessons, which means more revenue. Ideal for camps, clinics, and individual instruction, both indoor and outdoor. Get the feel of every lie on the course in one convenient footprint. 8 degree gradient, astroturf surface, 36" diameter, 29 lbs.

#71803

See page #28



## ▶ THE TOUGHLIE 360 UNIT

Increased interest in practice - More engaged students means more lessons, which means more revenue. Ideal for camps, clinics, and individual instruction, both indoor and outdoor. Get the feel of every lie on the course in one convenient footprint. 8 degree gradient, astroturf surface, 60" diameter, 90 lbs.

#71802



## ▶ THE LITTLE CHIPPER

The perfect target for a budget friendly short game area! These drums come in red, white, blue and yellow and are the perfect way to add multiple targets to your range without breaking the bank!

#77463 - Red drum  
#77464 - White drum  
#77465 - Blue drum  
#77466 - Yellow drum

## ▶ YARDAGE SIGN KITS

Mark your targets with these aluminum signs! Bolted to each barrel with a piece of 2" x 2" lumber on back.

#77467 - 25 Yard Sign Kit  
#77468 - 50 Yard Sign Kit  
#77469 - 75 Yard Sign Kit  
#77470 - 100 Yard Sign Kit



See page #50

## NEW PRODUCTS FOR THE RANGE

▶ EMPIRE DIVIDER 

These dividers are self-standing and easily moveable. A bigger twist to our Classic Range Divider, the Empire Divider can be made from any of our recycled plastic colors, and has a large space for a custom logo or message in the middle!

59½" L x 10" D x 24" H (20 lbs.)

#P060G - Green  
#P060BLK - Black  
#P060BRN - Brown  
#P060DRT - Driftwood  
#P060WN - Walnut  
#P060C - Custom

See page #45

▶ THE EXECUTIVE BAG STAND 

A modern twist on a timeless classic! This bag stand features club grooves on the back, a cup holder on one side and a storage box for your range finder, phone, wallet and keys on the other!

22" L x 29" W x 27" H (12 lbs.)

#54345 - Black  
#54346 - Brown  
#54347 - Green  
#54358 - Driftwood  
#54346WN - Walnut  
#54349C - Custom

See page #39

▶ 3 BAG RACK 

These 3 bag racks are ideal for courses that need easily movable bag storage options! Each rack is made from recycled plastic and can be easily moved or placed next to other racks for additional storage.

Dimensions 36" L x 18" D x 31" H (40 lbs.)

#C045BLK - Black  
#C045BRN - Brown  
#C045G - Green  
#C045D - Driftwood  
#C045WN - Walnut  
#C045C - Custom

See page #41

▶ 10 GALLON SQUARE CLUB CLEANER 

This 10 Gallon club washer looks great on any range! The top pulls off for easy water changing and brush replacement.

Dimension 19¼" L x 19¼" D x 22½" H (30 lbs.)

#77900 - Green  
#77901 - Brown  
#77902 - Black  
#77903 - Driftwood  
#77904 - Walnut  
#77900C - Custom

See page #42





## NEW PRODUCTS FOR THE COURSE



Color choices for all recycled plastic products

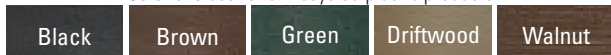

See page #137

### HAND SANITIZER STATION

Made from recycled plastic, these enclosures are perfect for any other high traffic areas at your facility! This is made with a movable base or an in-ground post mounting option. Station does not include hand sanitizer. Size: 48"L x 18"W x 18"H. Weight: 75 lbs.

- #406561-P – Green – Inground Post
- #406562-P – Brown – Inground Post
- #406563-P – Black – Inground Post
- #406564-P – Driftwood – Inground Post
- #406562WN-P – Walnut – Inground Post
- #405651-B - Green Portable Base
- #405652-B - Brown Portable Base
- #405653-B - Black Portable Base
- #405654-B – Driftwood Portable Base
- #405652WN-B – Walnut Portable Base

### CART DIVIDER

- Utilize your cart's full capacity in under 2 minutes!
  - Crystal clear, UV resistant construction.
  - Flexible & lightweight, durable and cold crack resistant.
  - Anti-bacterial and easy to clean with a bleach and water mixture.
  - Bungee cords are included, 16 gauge vinyl piece separates passengers.
  - These cart dividers currently do not fit carts with GPS units mounted in the front/EZ Go RXV Elite carts.
  - Drilling holes in your cart is required for installation of these units.
- Small style is 32"H x 32"W, designed to fit all Club Car models.  
Large style is 35"H x 32"W designed to fit all EZ Go and Yamaha models.

- #500200 - Club Car Divider
- #500201 - EZ Go/Yamaha Divider

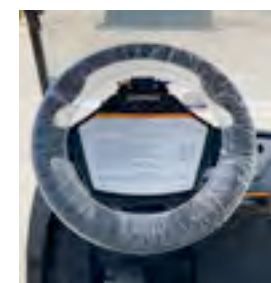

### DISPOSABLE STEERING WHEEL COVER

- Fully elasticized.
- Slip resistant, plastic design.
- Packed 500 per case.

#650WC

See page #137



See page #137

### COVID SIGNS

These aluminum signs with red vinyl decals used for the messages are made in-house in the U.S.A. These signs withstand the test of time!

See page #137



#500108 12" x 18"



#500100 12" x 12"



#500101 12" x 12"



#500102 12" x 12"



#500103 12" x 12"



#500104 12" x 12"



#500105 12" x 12"



#500106 12" x 12"



#500107 12" x 12"



### WITTEK ONE TOUCH

A huge improvement in ball retrieval made right here in the U.S.A!

Featuring a one-piece design, the Wittek OneTouch is the easiest ball retriever to both apply and use.

The Wittek OneTouch snaps on to your regular or tapered flagsticks in less than one second. The 1.5" hook on top can then be pulled up with any club in the bag, sliding back down into the cup on its own after retrieval.

Made from industrial strength nylon in the U.S.A, the Wittek OneTouch is the ball retrieval solution you've been waiting for.

Easy to apply & easy to use!

#Wittek1Touch

Qty. 1-8

Qty. 9-17

Qty. 18+

See page #77



## NEW PRODUCTS FOR THE COURSE



See page #111

### PORTABLE BOTTLE HOLDER

This bottle holder design was inspired by our bag stand, meaning it's just as easy to move! This unit fits bottles B, and C shown on page 110.

- #300GRN - Green
- #300BRN - Brown
- #300BLK - Black
- #300DRT - Driftwood
- #300WN - Walnut
- #300CST - Custom



- B - #41333 - 35 oz top Fill, Curved Neck 14" tall
- C - #41313 - 45 oz Bottom Fill, Curved Grip Neck 14" tall



See page #112

### MEGA A FRAME BOTTLE HOLDER

Storing and moving 32 divot mix bottles has never been easier! This A frame style holder is made from recycled plastic and is perfect for high traffic areas on your course where guests can replace empty bottles with full ones. When you need to move it, simply fold it up, grab one of the side handles, and carry it where you need to! This unit fits bottles B, and C shown on page 110.

- #T308BLK – Black
- #T308BRN – Brown
- #T308GRN – Green
- #T308DRT – Driftwood
- #T308WN – Walnut
- #T308C – Custom



- B - #41333 - 35 oz top Fill, Curved Neck 14" tall .
- C - #41313 - 45 oz Bottom Fill, Curved Grip Neck 14" tall



See page #104

### LAMINATED PLASTIC DISTANCE MARKERS

Made from extremely durable laminated plastic, these markers will withstand the test of time on your course! Stock markers are perfect for the fairway, and custom messages can be added to make OB, hazards, or no cart areas! Made from laminated plastic posts we can engrave any custom number or message you may need!

- #F136R - Red w/ White 100
- #F136W - White w/ Black 150
- #F136B - Blue w/ White 200
- #F136Y - Yellow w/ Black 250
- #F136C - Custom



## NEW PRODUCTS FOR THE COURSE

ALL PRODUCTS ARE MADE FROM  
RECYCLED PLASTIC AND MADE IN THE U.S.A.



## ▶ CAFÉ SOFA

Size: 36"L x 87"W x 35"H.  
Weight: 98 lbs. Includes cushion.  
#LCR813BLK - Black  
#LCR318BRN - Brown  
#LCR318GRN - Green  
#LCR318DRT - Driftwood  
#LCR318WHT - White  
#LCR318WN - Walnut  
#LCR318C - Custom



## ▶ CAFÉ LOVE SEAT

Size: 36"L x 58"W x 35"H.  
Weight: 74 lbs. Includes cushion.  
#C813BLK - Black  
#C318BRN - Brown  
#C318GRN - Green  
#C318DRT - Driftwood  
#C318WHT - White  
#C318WN - Walnut  
#C318C - Custom



## ▶ CAFÉ ARM CHAIR

Size: 36"L x 29"W x 35"H.  
Weight: 30 lbs. Includes cushion.  
#LC813BLK - Black  
#LC318BRN - Brown  
#LC318GRN - Green  
#LC318DRT - Driftwood  
#LC318WHT - White  
#LC318WN - Walnut  
#LC318C - Custom



## ▶ CAFÉ OTTOMAN

Size: 26"L x 24"W x 14"H.  
Weight: 21 lbs. Includes cushion.  
#LC807BLK - Black  
#LC807BRN - Brown  
#LC807GRN - Green  
#LC807DRT - Driftwood  
#LC807WHT - White  
#CLC807WN - Walnut  
#LC807C - Custom



## ▶ CAFÉ END TABLE

Size: 27"L x 24"W x 16"H.  
Weight: 21 lbs.  
#LC813BLK - Black  
#LC318BRN - Brown  
#LC318GRN - Green  
#LC318DRT - Driftwood  
#LC318WHT - White  
#LC318WN - Walnut  
#LC318C - Custom



## ▶ CAFÉ COFFEE TABLE

Size: 38"L x 26"W x 16"H.  
Weight: 51 lbs.  
#CT812BLK - Black  
#CT812BRN - Brown  
#CT812GRN - Green  
#CT812DRT - Driftwood  
#CT812WHT - White  
#CT812WN - Walnut  
#CT812C - Custom



## ▶ SONOMA DINING TABLE

Size: 64"L x 38"W x 30"H. Weight: 121 lbs.  
#C376BLK - Black  
#C376BRN - Brown  
#C376GRN - Green  
#C376DRT - Driftwood  
#C376WHT - White  
#C376WN - Walnut  
#C376C - Custom



## ▶ SONOMA BENCH

Size: 53"L x 15"W x 17"H. Weight: 35 lbs.  
#C377BLK - Black  
#C377BRN - Brown  
#C377GRN - Green  
#C377DRT - Driftwood  
#C377WHT - White  
#C377WN - Walnut  
#C377C - Custom

See pages #130 - 131

## NEW PRODUCTS FOR THE COURSE

## ▶ RECYCLED PLASTIC FIRE PIT

Hand crafted from recycled plastic lumber, this unit fits a 20 lb propane tank (not included) featuring a locking door. With a control panel and glass wind guards on each unit, it has never been easier to create a safe and comfortable experience for your guests.  
Size: 47"L x 35"W x 27"H.  
Weight: 185 lbs.  
#C600BLK - Black  
#C600BRN - Brown  
#C600GRN - Green  
#C600DRT - Driftwood  
#C600WN - Walnut  
#C600C - Custom



See page #132

## ▶ ROCKER ADIRONDACK

Size: 36"L x 30"W x 34"H.  
Weight: 38 lbs.  
#C431BLK - Black  
#C431BRN - Brown  
#C431GRN - Green  
#C431DRT - Driftwood  
#C431WHT - White  
#C431WN - Walnut  
#C431C - Custom



See page #124



## ▶ FOLDING ADIRONDACK

Size: 36"L x 31"W x 34"H.  
Weight: 33 lbs.  
#C430BLK - Black  
#C430BRN - Brown  
#C430GRN - Green  
#C430DRT - Driftwood  
#C430WHT - White  
#C430WN - Walnut

See page #124

## ▶ THE TRIFECTA TRASH &amp; RECYCLE RECEPTACLE



This unique unit offers a traditional look while both consolidating and promoting recycling at your facility! Three 22-gallon containers make it easy to separate bottles, cans and trash with tons of space for custom logos on and messages on any of the three receptacles! The Trifecta Receptacle is available in any of our recycled plastic color options.  
Size: 56"L x 20"W x 45"H.  
Weight: 210 lbs.  
#C455GRN - Green  
#C455BRN - Brown  
#C455BLK - Black  
#C455DRT - Driftwood  
#C455WN - Walnut  
#C455C - Custom



See page #115

Reorder easily @ [www.wittekgolf.com](http://www.wittekgolf.com)



### ▶ THE ESSENTIAL STAFF SHIRT

- 5.3-ounce, 100% cotton
  - Seamless double-needle 7/8" collar
  - Double-needle sleeves and hem
  - Taped neck and shoulders
  - Tearaway label
  - Featuring "Staff" screen printed on the front left chest/back shoulder area
  - Minimum Order: 12 shirts
  - Available in Black (PMS 426C), White(PMS White), Red (PMS 199C), Blue (PMS 7686C), Orange (PMS 2026C) and Yellow (PMS122C).
- Please specify color when ordering.

#GMA-G5000S -Small

#GMA-G5000M -Medium

#GMA-G5000L -Large

#GMA-G5000XL -XL

#GMA-G5000XXL -XXL

#GMA-G5000XXXL -XXXL



BACK

### ▶ THE PREMIUM STAFF SHIRT

Unparalleled breathability for superior cooling.

- 3.8 ounce, 100% polyester flat back mesh
- Tag-free label
- Moisture wicking
- Flat knit collar
- Taped neck
- 3 button placket with dyed to match buttons
- Set in, open hem sleeves
- Minimum Order: 12 shirts
- Available in: Black (PMS NTR BLACK C), White (PMS White), Red (PMS 200C), Blue (7686C), Gold (PMS1235C) and Neon Green (PMS 802C)

#GMA-ST640S -Small

#GMA-ST640M -Medium

#GMA-ST640L -Large

#GMA-ST640SXL -XL

#GMA-ST640XXL -XXL

#GMA-ST640XXXL -XXXL



### ▶ LEXAN

Our lexan logos can be added to almost any recycled or laminated plastic piece, giving your amenities a custom logo that really "pops"! Our color options are endless and we can make your lexan logo as big or small as you need it.



### ▶ ENGRAVED (W/ OR W/OUT COLOR FILL) —

Give your items a timeless look with an engraved logo. Using our state of the art routers, we can engrave almost any logo or text into your recycled plastic pieces and go back in and color fill them to really make it stand out! No gold/silver.



### ▶ BRONZE/ALUMINUM

A premium logo without the premium price tag. The high end look you've been waiting for has never been easier to attain. Simply send us your logo, we'll send back a proof and once it's approved production will begin!



Use your terms @ [www.wittekgolf.com](http://www.wittekgolf.com)



## RANGE ROVER BALL PICKER

Hot Seller

### Combining Versatility with Maneuverability

Front section, front caster fork, and wheel are all in one for the ultimate in flexibility, strength, maneuverability, and unsurpassed reliability. The Wittek Range Rover provides the most control and the highest rate of picking performance.

- Swiftest, most maneuverable picker on the market. Backs out of the toughest spots with ease.
- Powder coated finish provides ultimate protection and rust resistance.
- Assembles in just 15 minutes.

REVERSIBLE



### ▶ 3 GANG RANGE ROVER with Plastic Baskets

A great starter ball picker for any range. It is 9' wide, complete with push bar and mounting bracket. Weight 426 lbs.

**Holds 1,800 balls.**

#71413P - Black Discs

#71413PW - White Discs (For soft cover balls)



## ADDITIONAL FEATURES



### ADVANCED TURNING SYSTEM

Newly engineered tires on each end of the drum, combined with pillow block bearings, provide added reinforcement that greatly maximizes strength and maneuverability.

#71801 - Pillow Block Bearings

#71808 - Drum Section Tire



### ALL-IN-ONE SWIVEL CASTER FORK AND WHEEL

Provides more control, flexibility and maneuvering ability than any other picker on the market.

#71936 - Swivel Caster Fork

#71989 - Front Wheel/Tire/Axle/Bearings



### NEWLY DESIGNED NYLON WHITE AND BLACK DISCS

These lightweight, durable discs, maximize productivity on the range. Drums come standard with black discs. Upgrade to white for soft cover balls.

#71920 - Replacement Black Drum Section

#71920W - Replacement White Drum Section

#71932 - Disc Only - Black

#71932W - Disc Only - White(For soft cover balls).



### EXTRA HEAVY DUTY POST ASSEMBLIES

The only solid steel post assemblies in the industry provide greater strength and performance.

#71946 - 2 & 3 Gang Post Assembly

### Maneuverability

The Range Rover can be backed out of the tightest spots. The gangs will not get tangled, so there is no need to exit the vehicle while range is in use.

### Durability

Grease fittings have been placed on all critical wear points to extend the life of your picker.



### ▶ PLASTIC PICKER BASKETS 300 Balls Per Basket

Our picker baskets are made of a tough polyethylene that offers high strength and impact resistance. Lighter and more durable than wire baskets.

13"L x 19½"W x 10½"H ( 2 lbs.)

#71912



### ▶ STACKABLE PICKER BASKETS 300 Balls Per Basket

Redesigned with you in mind! Save on shipping with our brand new stackable picker baskets. Made from the same tough polyethylene that offers durability and impact resistance.

13¼"L x 20¼"W x 11"H (3 lbs.)

#71912S

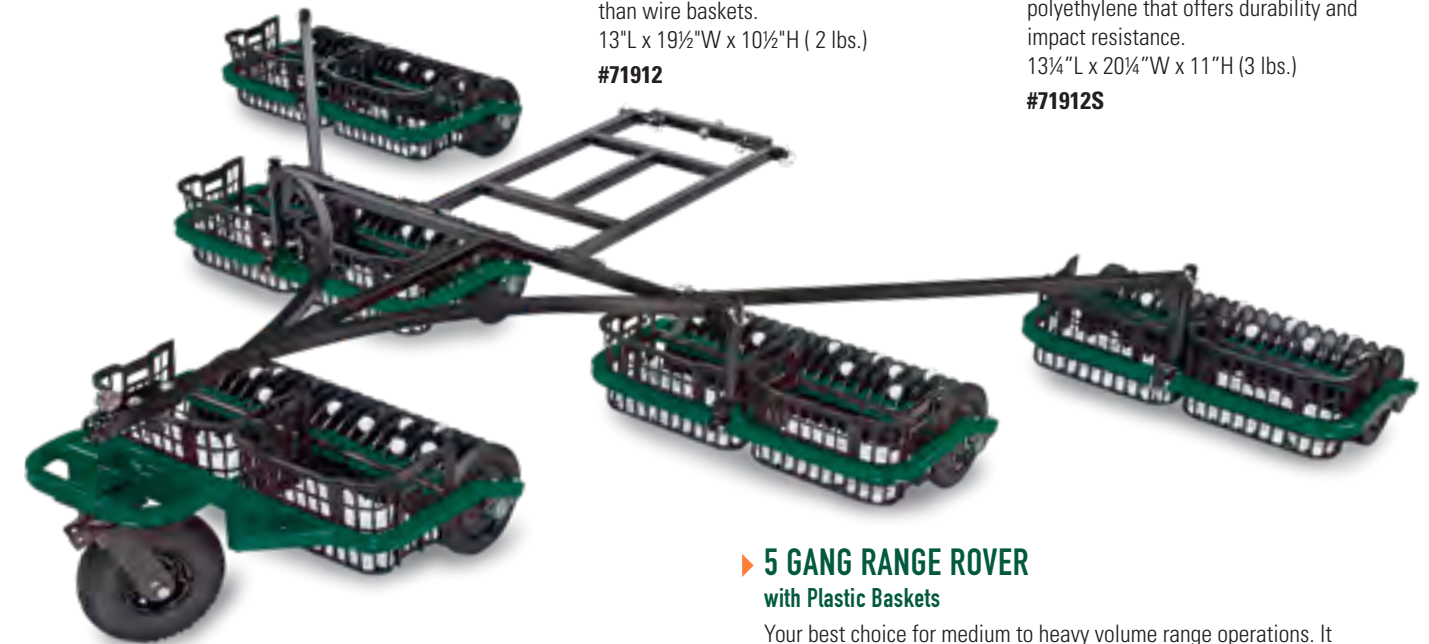

### ▶ 5 GANG RANGE ROVER with Plastic Baskets

Your best choice for medium to heavy volume range operations. It is 15' wide. Complete with push bar and mounting bracket. Weight 635 lbs. **Holds 3,000 balls.**

#71415P - Black Discs

#71415PW - White Discs (For soft cover balls)





## BALL HAWK PICKER

### The Ball Retriever Preferred By Most Driving Ranges

The Ball Hawk Series ball pickers contour to any terrain featuring a newly engineered advance turning systems.

*The picker of choice at the 2018 PGA Championship!*

- Powder coated finish provides ultimate protection and rust resistance.
- Assembles in just 15 minutes.



**BUILT NOT TO LAST  
BUT TO OUTLAST!**

#### ▶ 3 GANG BALL HAWK with Plastic Baskets

It is 9' wide and holds 1,800 balls, but can easily increase to a five gang that holds **3,000 balls**. Comes complete with push bar and mounting bracket. Weight 395 lbs.

#71403P - Black Discs

#71403PW - White Discs (For soft cover balls)



## ADDITIONAL FEATURES

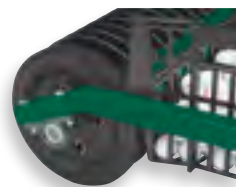

#### ADVANCED TURNING SYSTEM

Newly engineered tires on each end of the drum, combined with pillow block bearings, provide added reinforcement that greatly maximizes strength and maneuverability.

#71801 - Pillow Block Bearings

#71808 - Drum Section Tire



#### SPRING LOADED FORK ASSEMBLY

Provides more control, flexibility and maneuvering ability than any other picker on the market.

#71979 - Ball Hawk Caster Fork

#71989 - Front Wheel/Tire/Axle/Bearings

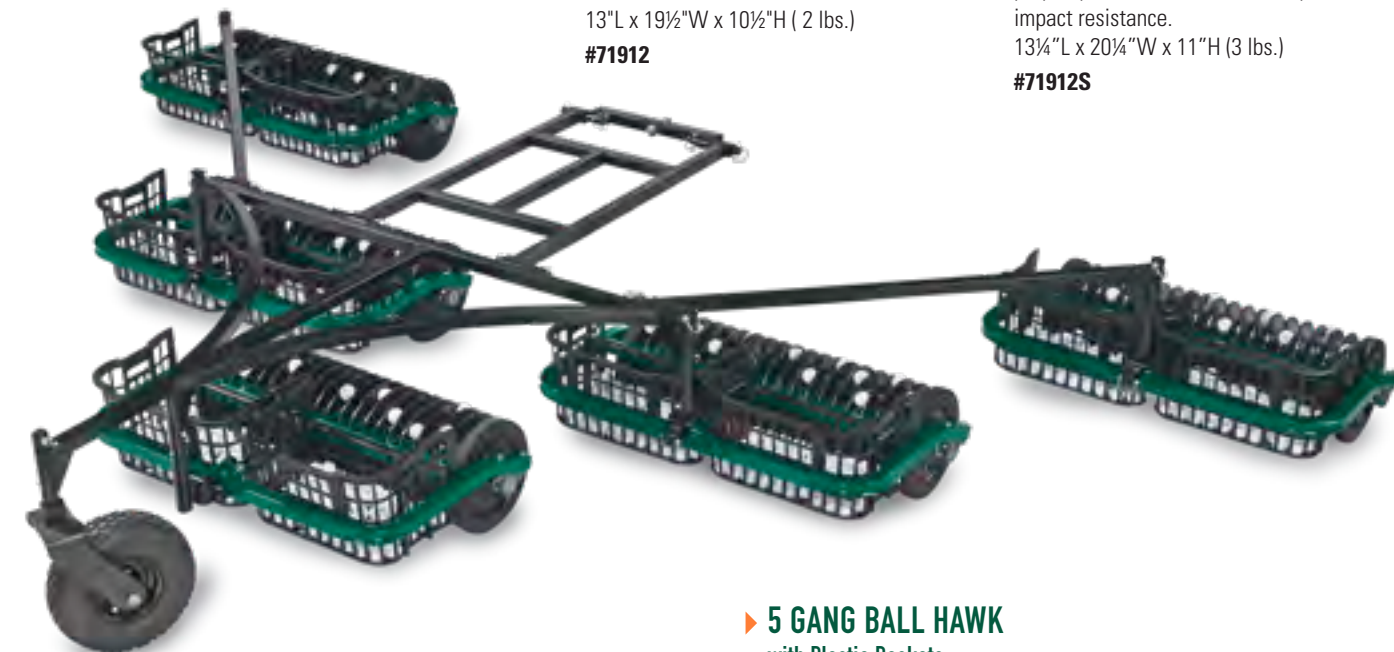

#### ▶ 5 GANG BALL HAWK with Plastic Baskets

15' wide, and comes complete with push bar and mounting bracket. Weight 585 lbs. **Holds 3,000 balls.**

#71405P - Black Discs

#71405PW - White Discs (For soft cover balls)



#### NEWLY DESIGNED NYLON WHITE AND BLACK DISCS

These lightweight, durable discs, maximize productivity on the range. Drums come standard with black discs. Upgrade to white for soft cover balls.

#71920 - Replacement Black Drum Section

#71920W - Replacement White Drum Section

#71932 - Disc Only - Black

#71932W - Disc Only - White (For soft cover balls)

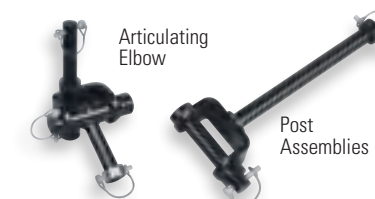

#### EXTRA HEAVY DUTY POST ASSEMBLIES & ARTICULATING ELBOW

The only solid steel post assemblies in the industry provide greater strength and performance.

#71946 - 2 & 3 Gang Post Assembly

#71940 - Articulating Elbow



#### ▶ PLASTIC PICKER BASKETS 300 Balls Per Basket

Our picker baskets are made of a tough polyethylene that offers high strength and impact resistance. Lighter and more durable than wire baskets.

13"L x 19½"W x 10½"H ( 2 lbs.)

#71912



#### ▶ STACKABLE PICKER BASKETS 300 Balls Per Basket

Redesigned with you in mind! Save on shipping with our brand new stackable picker baskets. Made from the same tough polyethylene that offers durability and impact resistance.

13¼"L x 20¼"W x 11"H (3 lbs.)

#71912S



## EAGLE LITE PICKER

### LIGHT MEETS MIGHT

The **lightest** ball retriever in the golf market. The Eagle Lite puts less pressure on the cart and allows for **faster picking time**.

*The picker of choice at the 2018 U.S. Open Championship!*

#### Benefits

- Less Pressure on Cart
- Faster Picking Time
- Lightest Ball Retriever in the market
- Stronger Nylon Discs
- Bearingless Picker
- Reversible

### REVERSIBLE



#### ▶ 3 GANG EAGLE LITE with Plastic Baskets

ONLY 240 pounds. It is 9' wide. Comes complete with push bar and mounting bracket.

**Holds 1,800 balls.**

#71423P - Black Discs

#71423PW - White Discs (For soft cover balls)

### ADDITIONAL FEATURES



#### FRONT WHEEL PACKAGE

Front wheel bracket and wheel allow added maneuverability when picking the range.

#71763 - Front Wheel Package

#71725 - Front Wheel (only)



#### ELBOW

The only solid steel elbow in the industry, provides greater strength and performance.

#71762 - Back Post Assembly



#### ▶ 5 GANG EAGLE LITE with Plastic Baskets

ONLY 470 pounds, It is 15' wide. Comes complete with push bar and mounting bracket. **Holds 3,000 balls.**

#71425P - Black Discs

#71425PW - White Discs (For soft cover balls)

### Durability

It's light, but built strong.

- 1 ¼" Powder Coated Steel Framework
- Solid Steel Posts
- All Nylon Discs
- Plastic Baskets
- Adjustable axle brackets



#### ▶ PLASTIC PICKER BASKETS

**300 Balls Per Basket**

Our picker baskets are made of a tough polyethylene that offers high strength and impact resistance. Lighter and more durable than wire baskets.

13"L x 19½"W x 10½"H ( 2 lbs.)

#71912



#### ▶ STACKABLE PICKER BASKETS

**300 Balls Per Basket**

Redesigned with you in mind! Save on shipping with our brand new stackable picker baskets. Made from the same tough polyethylene that offers durability and impact resistance.

13¼"L x 20¼"W x 11"H (3 lbs.)

#71912S



#### NEWLY DESIGNED NYLON WHITE AND BLACK DISCS

These lightweight, durable discs, maximize productivity on the range. Drums come standard with black discs. Upgrade to white for soft cover balls.

#71922 - Black Drum (includes axle bracket set)

#71923 - White Drum (includes axle bracket set)

#WGRM036 - Disc Only - Black

#WGRM037 - Disc Only - White (For soft cover balls)

Check your order history @ [www.wittekgolf.com](http://www.wittekgolf.com)



## SL90-STRAIGHT LINE PICKERS

### A NEW LEVEL OF PRODUCTIVITY

#### Coverage

Covers more terrain in less time.

#### Maneuverability

The SL90 Series Ball Picker has a 360 degree turning radius, allowing for effortless back up and turning. Can be pushed or pulled.

#### Durability

Super strong yet lightweight Tubular steel construction creates a ball picker with unsurpassed reliability. Fewer moving parts and straight-line design helps on extra tough terrain.

### REVERSIBLE DRIVE



#### SL90 SUPER LIGHTWEIGHT

with Plastic Baskets

Five sections. 18' wide with a ball capacity of 3,000.

Weight 629 lbs.

#71840P - Black Discs

#71840PW - White Discs (For soft cover balls)

### ADDITIONAL FEATURES



#### ALL-IN-ONE SWIVEL CASTER FORK AND WHEEL

Provides more control, flexibility and maneuvering ability than any other picker on the market.

#71936 - Swivel Caster Fork

#71989 - Front Wheel/Tire/Axle/Bearings



#### NEVER-MISS BALL DEFLECTORS

Perfectly designed adjustable deflectors mean you will "never-miss" a ball again.

#71817 - SL90 Deflector with Square Rod

#71817R - SL90 Deflector with Round Rod



#### PLASTIC PICKER BASKETS

300 Balls Per Basket

Our picker baskets are made of a tough polyethylene that offers high strength and impact resistance. Lighter and more durable than wire baskets.

13"L x 19½"W x 10½"H ( 2 lbs.)

#71912



#### STACKABLE PICKER BASKETS

300 Balls Per Basket

Redesigned with you in mind! Save on shipping with our brand new stackable picker baskets. Made from the same tough polyethylene that offers durability and impact resistance.

13¼"L x 20¼"W x 11"H (3 lbs.)

#71912S



#### SL90 SENIOR LIGHTWEIGHT

with Plastic Baskets

Three sections, 10' 7" wide with a ball capacity of 1,800. Weight 375 lbs.

#71830P - Black Discs

#71830PW - White Discs (For soft cover balls)



#### SL90 JUNIOR LIGHTWEIGHT

with Plastic Baskets

Two sections, 7' wide, with a ball capacity of 1,200. Weight 330 lbs.

#71820P - Black Discs

#71820PW - White Discs (For soft cover balls)



#### NEWLY DESIGNED NYLON WHITE AND BLACK DISCS

These lightweight, durable discs, maximize productivity on the range. Drums come standard with black discs. Upgrade to white for soft cover balls.

#71920 - Replacement Black Drum Section

#71920W - Replacement White Drum Section

#71932 - Disc Only - Black

#71932W - Disc Only - White (For soft cover balls)



#### SL90 A-FRAME

Required attachment for pushing the SL90 Series pickers. Complete with three couplers and 9' 6" long (Junior, Senior) or 11' 3" long (Super) ,with 3' adjustable spread.

#71601 - For Junior & Senior

#71603 - For Super



## PICKER ACCESSORIES



## ▶ THE PROTECTOR

Eliminates the need for heavy, expensive cages. Netting is made of strong, lightweight polypropylene. Allows constant air flow while protecting the driver. One size fits all rooftop carts. 44"W x 55"L Weight: 14 lbs.

#93527



## ▶ BALL HAWK, RANGE ROVER, &amp; EAGLE LITE GOLF CART ADAPTERS

Specify year and model of golf cart when ordering. Weight: 40-60 lbs.

#71927 - Yamaha, G-16, G-21, G-23

#71490 - Yamaha, G-27 & G-28 only

#71943 - Yamaha Adventure 1&2, Drive

#71928 - Club Car

#71951 - E-Z-Go Workhorse (specify year and style)

#71952 - E-Z-Go hauler 1200



## ▶ CONVERSION KIT

Contains all the necessary parts and attachments to convert your 3 Gang Ball Hawk & Range Rover to a 5 Gang. Plastic baskets included. Weight: 215 lbs.

#71404 - For Ball Hawk

#71402 - For Range Rover

#71422B - For Eagle Lite (Black)

#71422W - For Eagle Lite (White)



## ▶ SL90 A-FRAME

Required attachment for pushing the SL90 Series pickers. Complete with three couplers and 9' 6" long (Junior, Senior) or 11' 3" long (Super), with 3' adjustable spread.

#71601 - For Junior & Senior

#71603 - For Super



## ▶ SL90 GOLF CART ADAPTER

For mounting the SL90 to any conventional golf cart or utility vehicle. Complete with two ball hitches for securing A-frame. Specify year and model of golf cart when ordering. Weight: 40-60 lbs.

#71992 - E-Z-Go Workhorse (2001 to Current)

#71997 - Yamaha, G-16, G-21, G-23 only

#71890 - Yamaha, G-27 & G-28 only

#71977 - Yamaha, Adventure 1&2, Drive

#71998 - Club Car

#71999 - E-Z-Go hauler 1200



## ▶ SL90 CONVERSION KITS

Convert your present SL90 Ball Picker to a larger model. Kits include all necessary parts and outrigger attachments.

#71851 - Junior to Senior SL90

#71826 - Junior to Super SL90

#71852 - Senior to Super SL90

## PICKER ACCESSORIES

▶ PLASTIC PICKER BASKETS  
300 Balls Per Basket

Our picker baskets are made of a tough polyethylene that offers high strength and impact resistance. Lighter and more durable than wire baskets. 13"L x 19½"W x 10½"H ( 2 lbs.)

#71912

▶ STACKABLE PICKER BASKETS  
300 Balls Per Basket

Redesigned with you in mind! Save on shipping with our brand new stackable picker baskets. Made from the same tough polyethylene that offers durability and impact resistance. 13¼"L x 20¼"W x 11"H (3 lbs.)

#71912S



## ▶ REPLACEMENT PARTS

#71920 - Replacement Drum Section

#71920W - Replacement White Drum Section

#WGRM036 - Disc Only - Black

#WGRM037 - Disc Only - White

#71922 - Eagle Lite Black Drum Section (includes axle bracket set)

#71923 - Eagle Lite White Drum Section (includes axle bracket set)

#71811 - Wittek Tire Picker Drum Section

#71818 - Commercial Tire Picker Wire Basket

#WGRM020S - Easy-Picker/Range Mate Picker Basket .

#71801 - Pillow Block Bearings

#71919 - Tie Rods (including hardware)

#71989 - Front Wheel/Tire/Axle/Bearings

#71936 - Swivel Caster Fork (for Range Rover & SL90)

#71979 - Caster Fork (for Ball Hawk)

#71946 - 2 & 3 Gang Post Assembly

#71940 - Ball Hawk Articulating Elbow



#71919



#71801

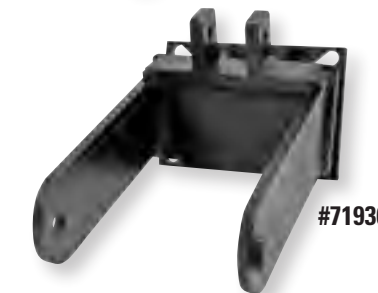

#71936



#71979



RANGE EQUIPMENT

# All Wittek ball washers are Engineered with purpose!

Delivers 10,000 - 20,000 sparkling clean range balls in a hour. Designed with "Soft Touch" Brush Lined Drum to clean without harming the golf ball. Reversible Brush Drum-extends the life of the brush drum against regular wear. The Basket kick-stand keeps washer open for easy maintenance. An all-weather motor cover protects against sun, rain and weather.

Feature Comparison	50G SUPERWASH	50G JUNIOR
<b>Balls per Hour</b>	20,000	10,000
<b>Feet of Cleaning Power</b>	15 Feet	9 Feet
<b>Motor</b>	1/2 H.P. Drive Motor	1/4 H.P. Drive Motor
<b>Hopper Capacity</b>	600 Golf Balls	600 Golf Balls
<b>Tank Capacity</b>	16 Gallons	8 Gallons
<b>Size</b>	52"L x 48"W x 50"H	35"L x 39"W x 41"H
<b>Weight</b>	221 lbs.	190 lbs.
<b>Electrical</b>	110 Volt (optional 220V )	110 Volt (optional 220V )



▶ **GOLF BALL SOAP LIQUID**  
Antibacterial and odor-control agents. 1 Gallon Container. 12" H x 6" W (9 lbs.)  
#73187



▶ **GOLF BALL SOAP POWDER**  
A mild, low sudsing detergent that eliminates dirt and grime. Color is purple. 10" H x 4.5 W (4 lbs.)  
#73185

## PARTS

### 50G SUPERWASH

- A. #73611 - Replacement Brush Drum 16.5" D x 16" W (52 lbs.)
- B. #73578 - Bearings with Housing
- C. #73186 - Drive Coupling
- D. #73566 - Rubber Strip Set (2 lbs.)
- E. #73179 - Vibrator Motor With Mounting Bracket
- F. #73167 - Exit Chute
- G. #73193 - Wire Hopper
- H. #73571 - Wheel for Dolly
- I. #M-73-26 - Valve
- J. #73580 - 50G Guide Set Assembly
- K. #74759-80 - GFCI Outlet
- L. #7219K22 - GFCI Outlet Box
- M. #7219K62 - GFCI Outlet Box Cover
- N. #M-73-43 - Rubber Latch
- O. #73169-0-02R - 50G Super Retrofit Kit – Waterproof Switch (w/ Thermal Unit) & Metal Cover

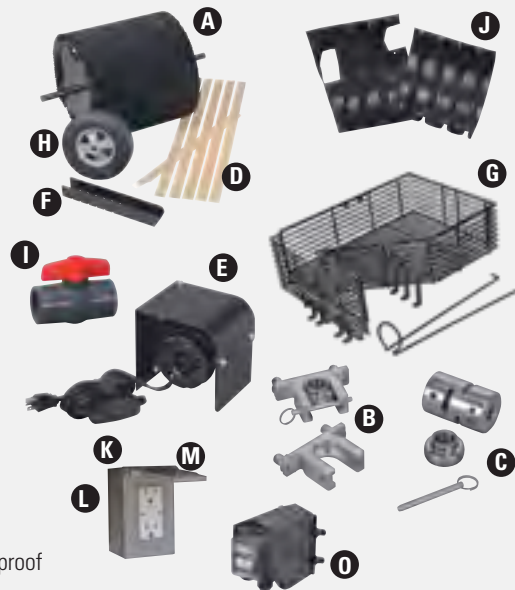

### 50G JUNIOR

- A. #73651 - Replacement Brush Drum 9"D x 12" W (20 lbs.)
- B. #73578 - Bearings with Housing
- C. #73186 - Drive Coupling
- D. #73587 - Rubber Strip Set
- E. #73179 - Vibrator Motor With Mounting Bracket
- F. #73167 - Exit Chute
- G. #73193 - Wire Hopper
- H. #73571 - Wheel for Dolly
- I. #M-77-59 - Valve
- J. #73655 - 50G Junior Guide Set Assembly
- K. #74759-80 - GFCI Outlet
- L. #7219K22 - GFCI Outlet Box
- M. #7219K62 - GFCI Outlet Box Cover
- N. #M-77-56 - Rubber Latch
- O. #73169-0-02JR - 50G Junior Retrofit Kit – Waterproof Switch (w/ Thermal Unit) & Metal Cover

RANGE EQUIPMENT

# 50G SUPERWASH BALL WASHER

## 20,000 BALLS PER HOUR

#73610  
#73610-220V - 220 Volt



# 50G JUNIOR BALL WASHER

## 10,000 BALLS PER HOUR

#73650  
#73650-220V - 220 Volt



All washers now come standard with a GFI switch for your added safety!





## WITTEK TWIST

The Twist is the latest addition to our already award-winning washer lineup. The Wittek Twist is made in the U.S.A of heavy gauge galvanized steel, a powerful drive motor and a self-contained water tank. The compact design is the perfect choice for low to medium volume golf courses and driving ranges.



### NOW GFI PROTECTED!

- CLEANING RATE: 15,000 Ball/Hour
- HOPPER CAPACITY: 500 Balls
- WATER CAPACITY: 8 Gallons
- ELECTRICAL: 110 or 220 Volt
- MOTOR: 1/3 HP
- DIMENSIONS: 33L x 19W x 30.5H
- WEIGHT: 94 lbs.
- 1 Year Warranty
- Drain Valve Kit Included
- Heavy duty nylon brush
- Unique Steel Spiral
- Debris Removal
- Motor is sealed against sun and moisture
- Heavy gauge steel

#73489

## ACCESSORIES & PARTS



A



B



C



D



E



F

- A. #P2BW16 - Original Washer Rebuild Kit  
 B. #P2BW10 - Original Spiral  
 C. #P2BW17 - Original Drain Valve  
 D. #P2BW18 - Original Wheel Kit  
 E. #P2BW07 - Original Brush On Shaft  
 F. #P2BWGFI - Replacement GFI Plug



## THE WITTEK ELITE SERIES DISPENSER



One-ball-at-a-time vending!

NOW GFI PROTECTED!



### ▶ ELITE SERIES BALL DISPENSER

- ACCOUNTABILITY. Our ball dispensers provide features and benefits far beyond other models. Account management, sales tracking, and cash accountability are just a few of the operational tools to help you evaluate, analyze, and control driving range ball sales.
- FLEXIBILITY. Utilizing our **one-ball-at-a-time vending**, you have the ability to deliver any number of balls in up to three bucket sizes. This means you can effectively boost sales by configuring a bucket pricing structure best suited to your facility.
- CONVENIENCE. By offering multiple payment options and locating the ball dispenser near the tee line your customer may conveniently make additional purchases. For the operator, this means increased sales revenue and a reduction in operating costs.
- Customized payment options: PIN, e-key, cash, and credit card.
- Can fit approximately 9,000 balls.
- Vends eleven balls per second.
- Front or rear load machines available.
- Token style supplies one bucket size reliably time after time after time 63" H x 36" L x 42" W (494 lbs.).

### ▶ VENDING COMBINATIONS

- #74760 - Token Only
- #74761 - Bill Acceptor Only
- #74763 - Token/Bill Acceptor
- #74759 - Dispenser Only
- Upgrade - 220 Volt

### 1. DROP COIN MECHANISM

#### ▶ DROP COIN MECHANISM

- Uses slotted security tokens.
- Built in coin return.
- Mechanism easily removable for cleaning.

#M-74-235 - Token

### 2. CASH

#### ▶ BILL ACCEPTOR

- High acceptance rate in any direction.
- Low maintenance.
- Self diagnostic front color LED.

#74760 - Bill Acceptor

### 3. CROSSFIRE

#### ▶ CROSSFIRE

- Accept credit cards right at your ball dispenser.
- Affordable; quick return on investment.
- Accept \$ Bills at Ball Dispenser (Optional).
- Reduces token abuse.
- Secure Transactions.
- Reduce employee time.

#74236 - Crossfire Kit - 3 Button Swipe .

#74238 - Crossfire - 3 Button Swipe w/ Bill Acceptor

### 4. E-RANGE

#### ▶ RANGE MANAGEMENT SOLUTIONS FOR:

Version 8.0 require any printer capable of printing on 8.5" x 11" paper to print reports. Requires any POS or receipt printer with an installed compatible windows printer driver. Additional hardware for communication is included.

Eliminate tokens; use wireless PIN numbers to activate your ball dispenser. POS integration; print wireless PIN numbers right on your POS receipt!

#74323 - E-Range

#74325-B - Blue e-Key

#74325-BLK - Black e-Key

#74325-G Green e-Key

#74325-Y - Yellow e-Key

See your invoices/statements @ [www.wittekgolf.com](http://www.wittekgolf.com)



## SIGNATURE BALL DISPENSER

Electrically operated, fully customizable and easy to use. The Wittek Signature Dispenser has four vending options available: Tokens, Bill Acceptor, E-Range and Credit Card. All four options can be used, either separately or in any combination. Options can also be easily added at a later date. Electrical: 110 Volt.



### ▶ THE SIGNATURE SPECS:

Size: 65"H x 39"W x 46"D. Weight: 615 lbs. (w/skid)  
Can fit approximately 8,200 balls  
Ball Count: Can be set to deliver 25, 30, 35, 40, 45 or 50 balls.  
(please specify when ordering).

### ▶ VENDING COMBINATIONS

#74750 - Dispenser Only  
#74751 - Token Only  
#74752 - Bill Acceptor Only  
#74754 - Token/Bill Acceptor  
#74758 - E-Range  
**Upgrade** - 220 Volt



Sliding security door for nighttime protection



Hinged rear panel to allow easier ball loading



Easy access

## VENDING OPTIONS

### 1. TOKENS

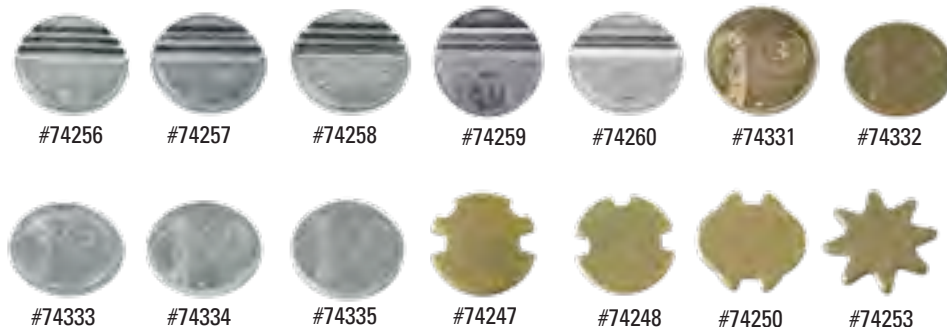

#74256 #74257 #74258 #74259 #74260 #74331 #74332  
#74333 #74334 #74335 #74247 #74248 #74250 #74253

### TOKENS

User friendly for your range customers.  
Sold in bags of 100. Bag dim. 9" x 7" x 1"  
(1.2 lbs.)

#74256 - "A" Token  
#74257 - "B" Token  
#74258 - "C" Token  
#74259 - "D" Token  
#74260 - "E" Token  
#74331 - #3 Medium Brass  
#74332 - #5 Large Brass  
#74333 - #2 Small Silver  
#74334 - #4 Medium Silver  
#74335 - #6 Large Silver  
#74247 - 4-Notch Round  
#74248 - 3-Notch Round  
#74250 - Butterfly  
#74253 - Star

## 2. CASH

### ▶ BILL ACCEPTOR

- High acceptance rate in any direction.
- Low maintenance.
- Self diagnostic front color LED.

#74233 - Bill Acceptor



## 3. CROSSFIRE

### ▶ CROSSFIRE

- Accept credit cards right at your ball dispenser.
- Affordable; quick return on investment.
- Accept \$ Bills at Ball Dispenser (Optional.)
- Reduces token abuse.
- Secure Transactions.
- Reduce employee time.

#74236 - Crossfire Kit - 3 Button Swipe

#74238 - Crossfire - 3 Button Swipe w/ Bill Acceptor



## 4. E-RANGE

### ▶ RANGE MANAGEMENT SOLUTIONS FOR:

Version 8.0 require any printer capable of printing on 8.5" x 11" paper to print reports. Requires any POS or receipt printer with an installed compatible windows printer driver. Additional hardware for communication is included.

Eliminate tokens; use wireless PIN numbers to activate your ball dispenser. POS integration; print wireless PIN numbers right on your POS receipt!

#74323 - E-Range



### BETTER MANAGEMENT, BIGGER PROFITS

e-range allows you to manage prepaid customer accounts; cash up front. It can pay for itself in less than a week. e-range can deactivate a lost or stolen account and replace it instantly with an accurate balance.

**Uses Wireless Pin Numbers**  
**1 Year Warranty On All Readers, Including Lightning Strikes!**

#74325-B - Blue e-Key  
#74325-BLK - Black e-Key  
#74325-G - Green e-Key  
#74325-Y - Yellow e-Key



Order online 24/7 @ [www.wittek golf.com](http://www.wittek golf.com)



Our mats do not leave green residue on your clubs!

## DURA-TURF MAT

The Wittek Dura-Turf Mat uses the world's finest synthetic grass for a reliable mat that features a shock absorbing pad and reinforced tee hole.

### ▶ WITTEK DURA-TURF MAT

Thickness: 1½"

Tee Holes: 5/8" Insert holes for rubber tees are centered on all sides and positioned 6 ½" inside the mat edge. Bottom side of holes are countersunk to accept base of rubber tee. 4 tee holes. Range ball tray not included.

Size: 59" x 59"

Weight: 35 lbs.

Thickness: 1½"

#78183



## TEACHING MAT

The perfect way to bring more golfers, more lessons and more revenue to your range!

### ▶ TEACHING MAT

Used to show proper alignment and swing path. All lines on the mat are permanently imbedded. Constructed of ½" nylon turf and secured to the foam base using a liquid urethane.

Tee Holes: 5/8" insert holes for rubber tees are centered on all sides and positioned 6½" inside the mat edge. Bottom side of holes are counter sunk to accept base of rubber tee. Range ball tray not included.

Size: 59" x 59"

Weight 35 lbs.

Thickness: 1¾" with pad

#78181



## QUATTRO MAT

The Quattro Mat is the most realistic simulation to a fairway on the market. Featuring an impact dampening system, which consists of highly elastic polyurethane fibers acting to absorb the impact of the club. The knitted nylon turf is bonded to an interface layer which protects the mat from tearing. Eight tee holes extend mat life. Bottom side of holes are countersunk to accept base of rubber tee. Range ball tray not included.

### ▶ QUATTRO MAT

Size: 59" x 59"

Weight: 39 lbs.

Thickness: 1¼"

#78180

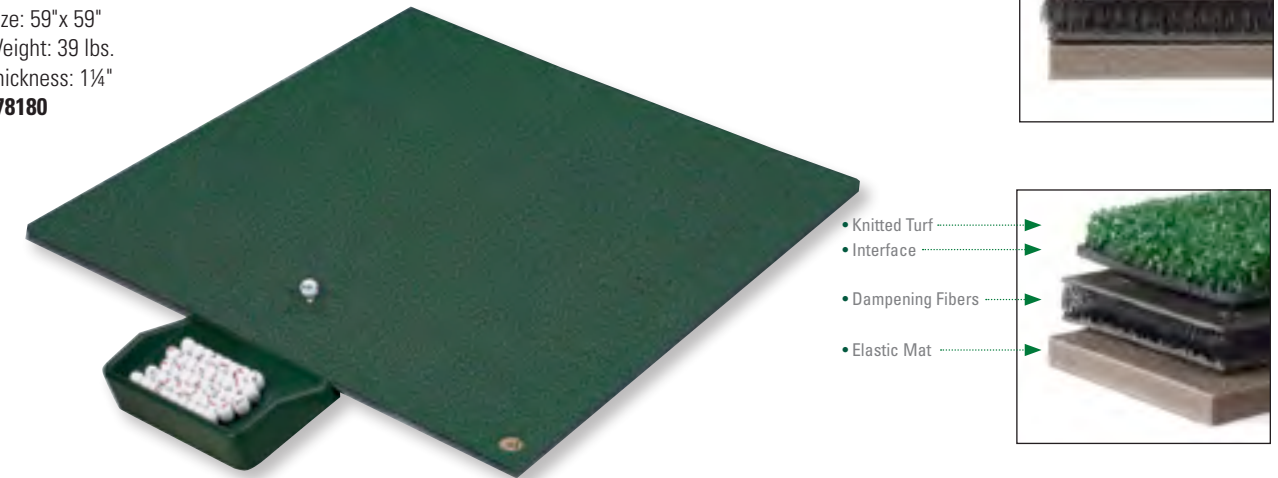

Specially engineered to lessen the physical shock of club and body at impact.

## MEGA MAT



The closest you can get to real turf. This mat gives you the feel of real grass without the bounce of other mats. Wood tees can be used on this mat to further simulate real grass. Now with two tee holes on each side to extend the life of your mat! Range ball tray not included.

### ▶ MEGA MAT

Size: 59" x 59"

Weight: 41 lbs.

Thickness: 1⅞"

#78197



Our mats do not leave green residue on your clubs!



Our mats do not leave green residue on your clubs!



#### ▶ WITTEK TEE LINE TURF

- 100% Made in the U.S.A.
- Long lasting and durable
- 100% Nylon - No green residue on clubs.
- Quality Control - Vertical Integration of companies
- Satisfaction guaranteed or money back
- 3 Year warranty for any manufacturer defects
- No Cutting Fees
- Face weight: 110 oz/sy
- Pile height: 1 1/8"

#78189



#### ▶ OCTAGON MAT

- Commercial Golf Mat in Octagon shape.
- Includes two Tee Holes for both left and right-handed use.
- 100% Woven Nylon
- Industrial bonded, exceeding industry standards for quality and durability.
- Weather resistant with ultra-violet protection.
- Resists tears, fading, curling, and separation.
- Mat is delivered rolled and can easily be rolled up and stored away!
- Easy to carry and store.
- Indoor / Outdoor use.

Size: 5'

Weight: 25 lbs.

Pile Height .5"

Backing 5/8" mm Foam

#304F

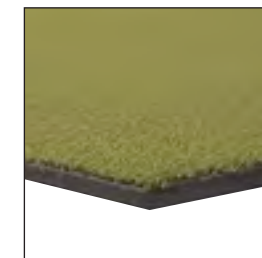
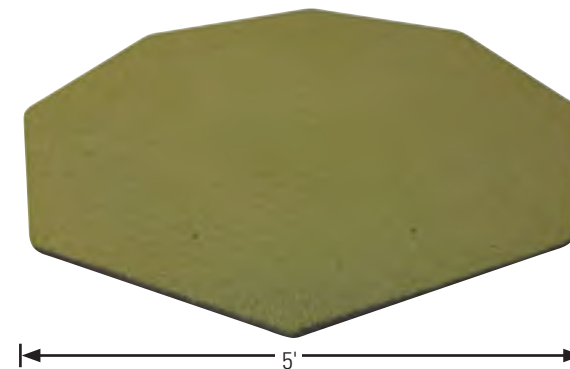

#### ▶ MINI MAT

- Includes two Tee Holes for both left and right-handed use.
- 100% Woven Nylon
- Industrial bonded, exceeding industry standards for quality and durability.
- Weather resistant with ultra-violet protection.
- Resists tears, fading, curling, and separation.
- Mat is delivered rolled and can easily be rolled up and stored away!
- Easy to carry and store.
- Indoor / Outdoor use.

Size: 3'W x 5'L

Weight: 11 lbs.

Pile Height .5"

Backing 5 mm Foam

#304D



#### ▶ THE TOUGHLIE SHORT GAME UNIT

Increased interest in practice - More engaged students means more lessons, which means more revenue. Ideal for camps, clinics, and individual instruction, both indoor and outdoor. Get the feel of every lie on the course in one convenient footprint. 8 degree gradient, astroturf surface, 36" diameter, 29 lbs.

#71803



#### ▶ THE TOUGHLIE 360 UNIT

Increased interest in practice - More engaged students means more lessons, which means more revenue. Ideal for camps, clinics, and individual instruction, both indoor and outdoor. Get the feel of every lie on the course in one convenient footprint. 8 degree gradient, astroturf surface, 60" diameter, 90 lbs.

#71802

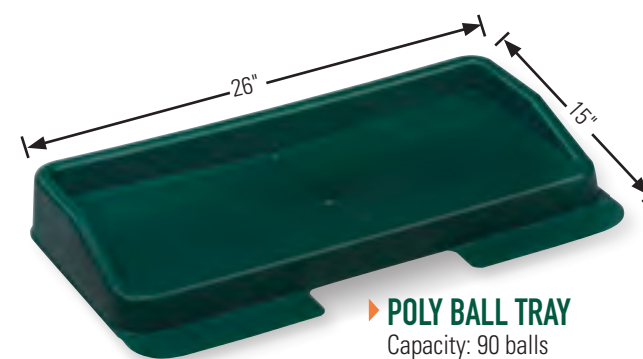

#### ▶ POLY BALL TRAY

Capacity: 90 balls

Size: 26"W x 15"D x 3 1/2" H.

Weight: 3 lbs.

#76154

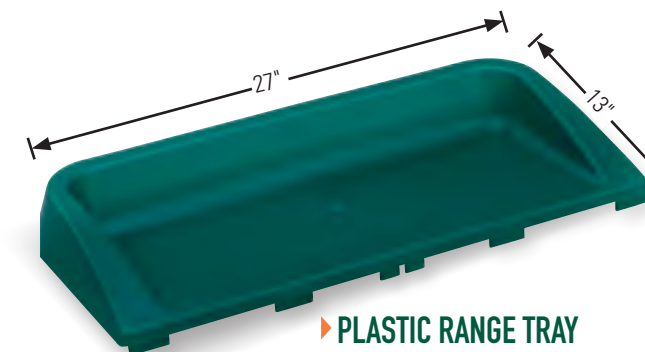

#### ▶ PLASTIC RANGE TRAY

Capacity: 90 Balls.

Size: 27"W x 13"D x 3 1/2" H.

Weight: 2.5 lbs.

#76155





Small crate shown in Driftwood, holds 200 balls



Large crate shown in Black holds 300 balls



▶ **RECYCLED PLASTIC BALL CRATES**

Made out of recycled plastic, with a built-in brush and holes on the bottom of the crate for easy water drainage, these crates withstand the test of time giving your facility that "championship look"! The small crates hold 200 balls and the large crate holds 300 balls, and both are available in six colors and the option to add your club's logo for a small upcharge!

- |   |   |
|---|---|
| <b>Small Ball Crate</b><br>10½" H x 10½" W x 21½" L<br>(14 lbs) | <b>Large Ball Crate</b><br>8½" H x 13½" W x 22" L<br>(15 lbs) |
| #76145BLK - Black   | #76140BLK - Black   |
| #76145BRN - Brown   | #76140BRN - Brown   |
| #76145DRT - Driftwood   | #76140DRT - Driftwood   |
| #76145GRN - Green   | #76140GRN - Green   |
| #76145WHT - White   | #76140WHT - White   |
| #76145WN - Walnut   | #76140WN - Walnut   |
| #76145C - Custom  | #76140C - Custom  |

▶ **ALUMACAST RANGE WOODS**

Durability and designed to handle day-to-day use. Made of one-piece aluminum casting. Neck area is reinforced with an iron shaft and wood dowel that runs through the entire head.

- #77215 - Men (RH) Black 43"
- #77216 - Men (LH) Black 43"
- #77217 - Women (RH) Light Blue 41"
- #77218 - Women (LH) Light Blue 41"
- #77219 - Junior (RH) Black 35"
- #77220 - Junior (LH) Black 35"



▶ **ADJUSTABLE RUBBER TEE**

Eliminate all the different tee sizes with this one tee. Rubber tee adjusts from 2⅞" to 3¼". Fits all traditional grass mats. 2" diameter base.

#78825



▶ **WOOD TEE HOLDERS**

Designed for use with all grass mats. Holds a wooden golf tee that can be adjusted to the golfer's preference. Made in USA.

Packed 50/Bag.

- #78823 - 1" Tee Holder
- #78820 - 1¼" Tee Holder
- #78824 - 1½" Tee Holder
- #78821 - 2" Tee Holder

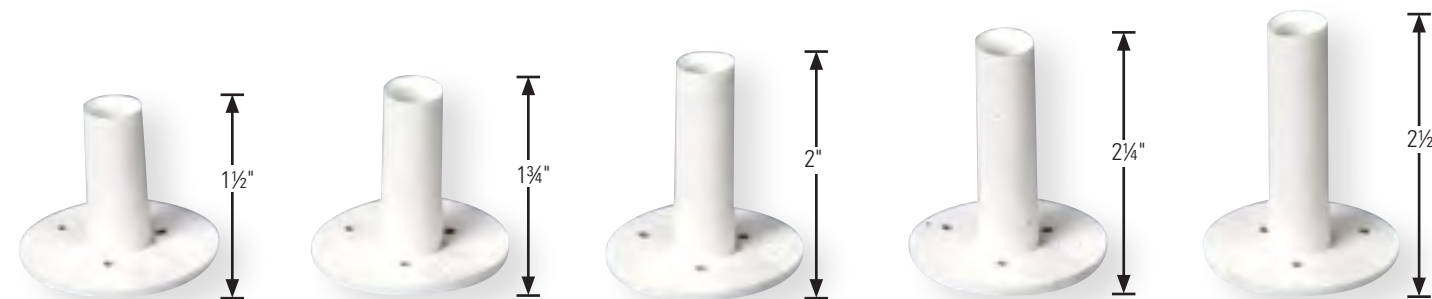

▶ **DURA RUBBER TEES**

Featuring seven different sizes. Designed to fit all commercial driving range mats. Color: White. 50 tees poly-bagged. Weight 2 lbs. Made in USA. 2" diameter base. Packed 50/Bag.

- #78810 - 1½" White
- #78811 - 1¾" White
- #78812 - 2" White
- #78813 - 2¼" White
- #78814 - 2½" White
- #78815 - 2¾" White
- #78816 - 3" White
- #78827 - 3¼" White
- #78828 - 3½" White

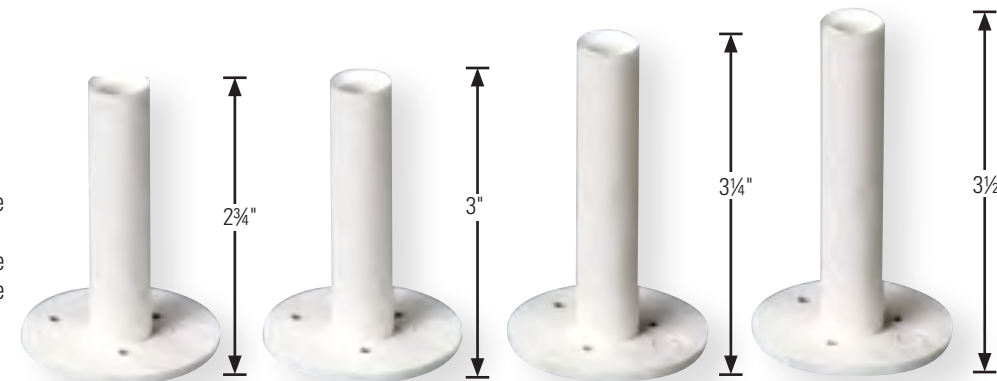



# Introducing... Range Buddy by Wittek Golf

*The easiest, most inexpensive way to give your range's guests the most accurate distances to your targets!*

## It's as easy as 1,2,3!

1. Download the app.
2. Set up your course's account.
3. Add your range's targets and mark their GPS coordinates.

Once you have your range set up, your guests can download the app and get personalized distances to each and every target, no matter where your tee line is or what station they're hitting from!

## ▶ RANGE BUDDY #RANGEBUDDY

**Your course pays the yearly fee and your members and guests get unlimited use!**



## ▶ DIVOT PATTERN SIGN

Sign has a hardscape back.  
18" H x 24" W x 10.5" L (10 lbs)  
#400854 - Single Sided



## ▶ WILSON PREMIUM PRACTICE BALLS

Wilson's premium practice balls are ideal for any practice facility. With more spin than the regular range ball at a relatively similar price, your golfers will love them! Available in white w/ black stripes. Packed 24 dozen per box.

#77809 - White Ball /Black Stripes



## ▶ WILSON RANGE BALL

Wilson's top range ball is available in White with Black stripes, White with Red stripes or Yellow with Black stripes. Packed 24 dozen per box.

#72802 - White Ball/Black Stripes  
#72803 - White Ball/Red Stripes  
#72804 - Yellow Ball/Black Stripes



## ▶ FLOATER RANGE BALL

Designed and developed specifically for aqua ranges. Compression measures between 85 and 90. Two piece construction with good feel, click and distance. Packed 24 dozen per box.

#72503 - White Ball /Black Stripes



## ▶ WILSON LIMITED RANGE

Wilson's limited flight range ball is designed for ranges with limited landing areas. Available in White with Black stripes or Yellow with Black stripes. Packed 24 dozen per box.

#72902 - White Ball/Black Stripes  
#72904 - Yellow Ball/Black Stripes

## ▶ RANGE BALL STORAGE BIN



This ball box makes refilling your range baskets a breeze! Made exclusively from recycled plastic with a locking mechanism on the front, this box can be left outside all day and night, even in the harshest conditions!  
28" H x 21" W x 32" L (75 lbs)

#TL305BLK - Black  
#TL305BRN - Brown  
#TL305GRN - Green  
#TL305DRT - Driftwood  
#TL305WN - Walnut  
#TL305C - Custom



## ▶ RANGE ALIGNMENT ROPE

Easily set up your range with that perfect appearance. The rope is marked every 10' so the tee line is uniform for safety. It makes setting bag stands or tee dividers perfect every time. 6½" x 6½" (1½ lbs.).

#77210 - 100' Yellow  
#77211 - 100' Green/White

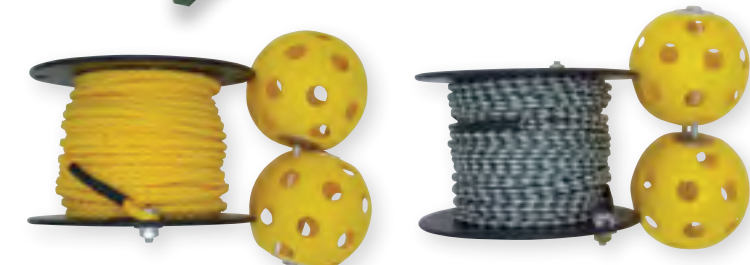



# RANGE BAGS

## STACKABLE RANGE BAGS

Our popular bags are stackable and very durable. Featuring one-piece construction with square bottom.

Drawstring top with cord lock.

Available in 3 colors: Red, Green and Black.

Size	Dimensions	Ball Capacity	Red	Green	Black
Warm-Up	9" W x 7¼" H	30-35	#76370	#76375	#76365
Small	9¾" W x 8" H	45-50	#76371	#76376	#76366
Medium	10¾" W x 9¼" H	65-70	#76372	#76377	#76367
Large	11½" W x 10¾" H	95-100	#76373	#76378	#76368



## CANVAS RANGE BAGS

A range favorite. These heavy duty cotton bags come with double cord drawstring and brass grommets.

Available in 3 colors: Red, Green and Black.

Size	Dimensions	Ball Capacity	Red	Green	Black
Warm-Up	9" W x 7" H	20-25	#76300	#76305	#76340
Small	9¼" W x 9" H	40-45	#76301	#76306	#76341
Medium	10¾" W x 10¾" H	65-70	#76302	#76307	#76342
Large	10¾" W x 13¾" H	95-100	#76303	#76308	#76343



## CANVAS PERSONALIZED RANGE BAGS

Cordura and canvas range bags can be enhanced by embroidering or screen-printing your name or logo. For logos, send us camera-ready art work by email. For names, simply spell out the name over the phone.

Art charges may apply. Please call for details.

#76304



Customization done in house!

## MESH RANGE BAGS

Lightweight and economical best describe our strong polyester mesh bags. Single draw string with cord lock.

Available in 4 colors: Royal Blue, Green, Yellow and Black.

Size	Dimensions	Ball Capacity	Royal Blue	Green	Yellow	Black
Warm-Up	7" W x 6¾" H	15-20	#76310	#76315	#76320	#76324
Small	8" W x 10½" H	45-50	#76311	#76316	#76321	#76325
Medium	9¾" W x 11" H	60-65	#76312	#76317	#76322	#76326
Large	11½" W x 14" H	95-100	#76313	#76318	#76323	#76327

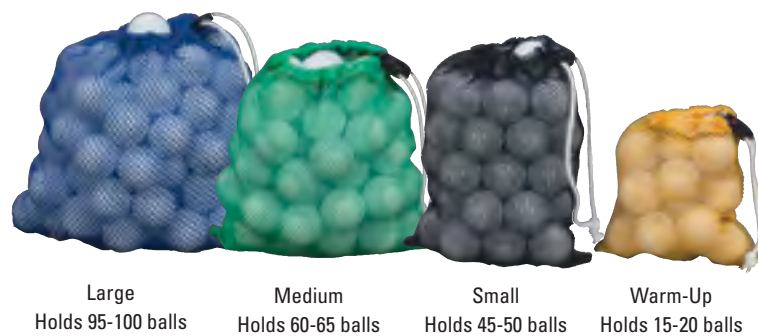

See page 18 for Range Balls

# RANGE PAILS & BASKETS

Plastic baskets retain their strength even in extreme temperatures.



Utility Holds 300-325 balls    Jumbo Holds 150-175 balls    Large Holds 100-110 balls    Medium Holds 70-75 balls    Small Holds 40-45 balls    Warm-Up Holds 25-30 balls

Size	Ball Capacity	Black	Green	Yellow	Height	Top Diameter
Warm-Up	25-30	#76289	#76291	#76295	5"	6¾"
Small	40-45	#76277	#76280	#76286	5¾"	7¾"
Medium	70-75	#76278	#76281	#76287	8½"	8¾"
Large	100-110	#76279	#76282	#76288	9¾"	10"
Jumbo	150-175	#76290	#76292	#76296	8¼"	12¾"
Utility	300-325	#76273	#76274	#76276	11¼"	16"

## ▶ SUPER JUMBO UTILITY BASKETS

Convenient carry handles provide easy handling.

Holds over 600 golf balls.

Size: 14"H x 19" Top Diameter

Weight: 3.5 lbs.

#76462 - Green



## ▶ WINDY CITY CRATES

Made of durable Roto-molded plastic, these crates hold up to 300 balls. Simply rub the face of your iron across the soft bristle brush to release the balls.

#760ECBN - Brown

#760ECGN - Green



Color choices for all recycled plastic products

- Green
- Black
- Brown
- Driftwood
- Walnut

## ▶ RANGE PAIL ORGANIZER

Holds up to 75 pails. Goes well next to our Wittek Ball Dispensers, and a great way to clean up the range. Made from recycled plastic, so it will not rust. Size: 33¼"H x 49½"W x 33"L. Weight: 8 lbs.

#74481 - Green

#74482 - Black

#74483 - Brown

#74484 - Driftwood

#74485 - Walnut

#74485C - Custom

## ▶ STACKING CRATES

A mesh bottom so water drains through. Made of high density polyethylene. Color: Red.

#76425 - Small

Holds 276 balls

12" L x 16" W x 9" H (2 lbs.)

#76450 - Large

Holds 576 balls

16" L x 24" W x 9" H (3 lbs.)

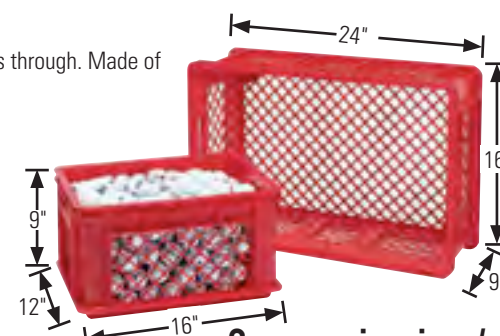

See your invoices/statements @ [www.wittek.com](http://www.wittek.com)



## GOLF BALL RETRIEVERS

Zipper Closure



### ▶ THE ORIGINAL BAG SHAG

Made of heavy duty canvas with metal zippers. Ball capacity: 75 Balls 7"L x 7"W x 27"H (2½ lbs.)

- #77050 - Blue
- #77051 - Red
- #77053 - Black
- #77054 - Hunter Green
- #77052 - Camouflage
- #77011 - Replacement Clips (3 Per Set)

### ▶ SHAG BAG HOLDER

Make your bag shags last and keep your practice area green with this practical and durable storage solution! Available in all our recycled plastic color options, holds 4 bags.

- #77000BLK – Black
- #77000BRN – Brown
- #77000GRN – Green
- #77000DRT – Driftwood
- #77000WN – Walnut
- #77000C – Custom

### ▶ DOUBLE SHAG BAG HOLDER

Conveniently store your practice greens essentials in a neat, stylish and stable way!

- #77001BLK – Black
- #77001BRN – Brown
- #77001GRN – Green
- #77001DRT – Driftwood
- #77001WN – Walnut
- #77001C – Custom

### ▶ RANGER BAG SHAG

When bag is full, simply tip over to empty. Heavy weight nylon is water resistant. Metal supports prevent ripping. One year guarantee! 100 ball capacity. 7"L x 7"W x 27"H (2½ lbs.)

- #77064 - Green
- #77065 - Red
- #77066 - Black

### ▶ BALLSHAG TUBE WITH CAP

Picks up balls with ease, and the cap holds the balls in the tube. Made of aluminum. 23 ball capacity.

- #77010 - Ballshag Tube
- #77011 - Replacement Clips (3 per set)

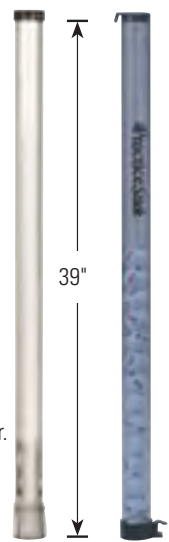

#77010 #77015

### ▶ DOUBLE SHAG BAG STAND

Rest your bag shags up against this clever stand to keep your practice green tidy and your bag shags easily accessible! Comes with two spikes on the bottom!

- #77002BLK – Black
- #77002BRN – Brown
- #77002GRN – Green
- #77002DRT – Driftwood
- #77002WN – Walnut
- #77002C – Custom

### ▶ PERSONALIZED BAG SHAGS

Imprint your range or course name! Colors: Black, Red, Blue, Hunter Green. Minimum order: 12.

- Art charges may apply.
- #77060 - Personalized Bag Shags
- #76304 - One Time Art/Screen Charge



Open Top



### ▶ HAV-A-BALL RANGE BALL PICKER

Works great under all conditions: Greens, fairways, rough, sand traps, even in standing water! (25 lbs.)

- Ideal for Hard to Reach Areas.
- Requires No Maintenance.
- Holds 25-30 dozen balls.
- Easy to assemble.

#71925 - Hav-A-Ball Picker -



### ▶ QUICK COLLECTOR

The ultimate practice green solution! ComfortGel grips provide long term comfort. Makes golf ball gathering quick and easy. Flexible steel cage picks up and gathers balls. Holds about 36 golf balls.

11"L x 10"W x 48"H (5 lbs.)

#93964 - Quick Collector



### ▶ BALL POPPER

Here's the best possible way to recover buried and embedded balls on your range.

Available in 55" and 37".

#77005 - Long Ball Popper, 55" Length (2½ lbs.)

#77006 - Shorty Ball Popper, 37" Length (2 lbs.)



## GOLF BALL RETRIEVERS

### ▶ THE MINI MIGHT PICKER

Featuring powder coated frames and the same long-lasting nylon discs as the Eagle Lite! With an 11-disc section and a plastic basket, this is the perfect solution for those crowded practice greens and short game areas, perfect for your employees or golfers to use to keep the green clean!

300 ball capacity.

#71455P - Black Discs



### ▶ CLEAN SWEEP

Fast, efficient way to remove balls from your practice green. Lightweight, durable PVC construction rolls smoothly over the green.

Available in 42" and 52"

#77040 - Clean Sweep

42" Wide (5 lbs.)

#77045 - Jumbo Clean Sweep

52" wide (6 lbs.)



### ▶ CLEAN SWEEP HOLDER

The clean sweep holder is a perfect way to keep your practice area clean and organized! Made from durable recycled plastic and caps for added support, they will never chip, peel or splinter and are sure to stand out at your facility!

- #77048 - White Holder w/ Green Caps
- #77049 - Green Holder w/ White Caps,

Order online 24/7 @ [www.wittekgolf.com](http://www.wittekgolf.com)



## BAG STANDS

▶ **ECONOMY CADDY RACK**

Long lasting construction, made of 1" O.D. powder coated tubular steel. Stackable to conserve space. 25" L x 16" W x 25" H ( 7 lbs.)

#77526 - Dark Green  
#77527 - Black

▶ **PRO 2000 BAG STAND**

Removable stopper to add sand for additional weight. 23" L x 16" W x 30" H ( 9 lbs.)

#77590 - Black  
#77591 - Hunter Green

Patent No. 5,695,312



Top View

▶ **PRO 2000 DELUXE BAG STAND**

Two drink receptacles. Convenient twin trays. Three club rest slots on both sides. 22" L x 16" W x 31" H ( 11 lbs.)

#77530 - Black  
#77531 - Hunter Green

RECYCLED PLASTIC BAG STANDS 

Two tone and custom top bag stands are our specialty! Please call to create your very own!

▶ **SINGLE POST BAG STAND**

Designed for turf ranges, this unit has 3 spikes holding the stand in place, while also allowing for easy relocation. 8" L x 12" W x 30" H ( 5 lbs.)

#P093BLK - Black  
#P093BRN - Brown  
#P093G - Green  
#P093D - Driftwood  
#P093WN - Walnut  
#P093C - Custom

▶ **THE CLASSIC BAG STAND**

A favorite on ranges everywhere. Folds up for easy storage. Hole drilled for alignment stick. 22" L x 16" W x 33" H ( 11.5 lbs.)

#54353 - Black  
#54354 - Brown  
#54355 - Green  
#54356 - Driftwood  
#54345WN - Walnut  
#54345C - Custom

▶ **THE SIGNATURE BAG STAND**

This fold-up bag is a sharp addition to any area, with extra room for a drink holder. Hole drilled for alignment stick. 22" L x 19" W x 33" H ( 12 lbs.)

#54351 - Black  
#54352 - Brown  
#54358 - Green  
#54357 - Driftwood  
#54352WN - Walnut  
#54352C - Custom

Color choices for all recycled plastic products

Black

Brown

Green

Driftwood

Walnut

▶ **THE CHAMPION BAG STAND**

Featuring club grooves, tee holes and a cup holder! This bag stand has it all! 23" L x 19" D x 26½" H

#54320 - Black  
#54321 - Brown  
#54322 - Green  
#54323 - Driftwood  
#54321WN - Walnut  
#54320C - Custom

▶ **THE EXECUTIVE BAG STAND**

A modern twist on a timeless classic! This bag stand features club grooves on the back, a cup holder on one side and a storage box for your range finder, phone, wallet and keys on the other! 22" L x 29" W x 27" H ( 12 lbs.)

#54345 - Black  
#54346 - Brown  
#54347 - Green  
#54358 - Driftwood  
#54346WN - Walnut  
#54349C - Custom



## BAG RACKS

### METAL BAG RACKS

This line features 1/8" PVC coating over zinc galvanized 2 3/8" round tubing. Expanded metal is also PVC coated. All fasteners are corrosion resistant.



- #43260 - Green/Black Single Bag Rest, 8'  
Holds 8 Bags  
8' L x 39" W x 32" H (170 lbs.)  
#43265 - Green/Black Single Bag Rest, 6'  
Holds 6 Bags  
6' L x 39" W x 32" H (120 lbs.)



- #43250 - Green/Black Double Bag Rest, 8'  
Holds 16 Bags  
8' L x 40" W x 32" H (230 lbs.)  
#43255 - Green/Black Double Bag Rest, 6'  
Holds 8 Bags  
6' L x 40" W x 32" H (170 lbs.)



## RECYCLED PLASTIC BAG RACKS

### ▶ 3 BAG RACK

These 3 bag racks are ideal for courses that need easily movable bag storage options! Each rack is made from recycled plastic and can be easily moved or placed next to other racks for additional storage. Dimensions 36"L x 18"D x 31"H (40 lbs.)

- #C045BLK - Black  
#C045BRN - Brown  
#C045G - Green  
#C045D - Driftwood  
#C045WN - Walnut  
#C045C - Custom



Color choices for all recycled plastic products

Black Brown Green

Driftwood Walnut

### ▶ MODULAR 5 BAG RACKS

This design made from high quality recycled plastic is great for around the clubhouse or restaurant. Each unit holds up to five bags and is exceptional in applications such as a wall mounting, back to back or side to side. Dimensions 67"L x 18" W x 32"H ( 64 lbs.).

- #C048BLK - Black  
#C048BRN - Brown  
#C048G - Green  
#C048D - Driftwood  
#C048WN - Walnut  
#C048C - Custom



Need more storage? Put two racks  
back-to-back or side to side!

Chat with specialists @ [www.wittekgolf.com](http://www.wittekgolf.com)



## CLUB CLEANERS

▶ 10 GALLON SQUARE CLUB CLEANER 

This 10 Gallon club washer looks great on any range! The top pulls off for easy water changing and brush replacement.  
Dimension 19¼" L x 19¼" D x 22½" H (30 lbs.)

- |                    |                  |
|--------------------|------------------|
| #77900 - Green     | #77904 - Walnut  |
| #77901 - Brown     | #77900C - Custom |
| #77902 - Black     |                  |
| #77903 - Driftwood |                  |



Color choices for all recycled plastic products

Black    Brown    Green

Driftwood    Walnut

▶ RECYCLED CLUB WASHER 

Rugged construction includes 5-gallon (19 L) bucket and hand brush.  
32" H x 17" x 17" (top) 32 lbs.

- |                    |                     |
|--------------------|---------------------|
| #405550 - Green    | #405552 - Black     |
| #405551 - Brown    | #405553 - Driftwood |
| #405551WN - Walnut |                     |
| #405551C - Custom  |                     |



See page 113 for the Windy City divot mix container.  
See page 116 for the Windy City trash container.

## ▶ WINDY CITY SERIES CLUB WASHER

- Club Washer includes 2 brushes and lid.
  - 8-Gallons (30L).
  - Attractive side panels dress up the range or tee area.
  - UV – Resistant, roto-molded plastic construction.
- 19" H x 16" W x 16" D.

- |                              |
|------------------------------|
| #778GN - Green               |
| #778BN - Brown               |
| #778BK - Black               |
| #WG89802 - Replacement Brush |



## ▶ DELUXE CLUB CLEANER

Recycled lumber frame contains the club cleaner. Two oversized 9" x 12" nylon brushes to ensure effective cleaning.

- Rotate brushes for even wear and double life.
  - Maintenance free exterior.
- 29" H x 14" x 14" (top) 21 lbs.

- |                               |                    |
|-------------------------------|--------------------|
| #77855 - Green                | #77858 - Black     |
| #77856 - Brown                | #77859 - Driftwood |
| #77856WN - Walnut             |                    |
| #77856C - Custom              |                    |
| #WGMB9802 - Replacement Brush |                    |



Patent No. 5,695,312

## ▶ ADVANCED SPEEDEE CLUB CLEANER

Two rotating nylon brushes. One firm brush for irons, one soft brush for woods. Tank holds up to 4 gallons. Heavy-duty ¼ H.P. motor. Operates from 110 volt outlet. Sealed flange bearings assure no freeze up of rotating shaft.  
24" H x 23" W x 19" D 85 lbs.

- |  |
|--|
| #41200 - Advanced Speedy Club Cleaner                              |
| #41106 - Replacement Woods/Irons Brush Assembly (Mounted to Shaft) |



## ▶ ULTIMATE CLUB CLEANER

Bucket stands 18" high for fast and easy cleaning of irons. Two oversized (8½" x 10") nylon brushes to ensure effective cleaning. Rotate brushes for even wear and double life. Attached club rest.  
19" H (with stand) x 12" x 12" (top) 13 lbs.

- |                            |
|----------------------------|
| #77834 - Green             |
| #77837 - Black             |
| #77840 - Replacement Brush |



## CLUB CLEANERS



## ▶ PRO 2000 CLUB CLEANER

Safely cleans woods and irons. Two sets of removable oversized soft nylon bristle brushes that insure safe and effective cleaning. Rotate brushes for even wear and double life. Ultra strong all polyethylene construction for long lasting wear. Comes with absorbent cotton towel.  
24" H x 12.5" W x 16" D 21 lbs.

- |   |
|---|
| #77880 - Hunter Green                         |
| #77881 - Black                                |
| #77803 - Replacement Brush For Woods          |
| #77806 - Replacement Brush Irons (2 Required) |



## ▶ RANGE MATE CLUB WASHER

- Cleans woods, irons and grips.
  - Eliminates splashing.
  - Includes heavy duty powder coated wire stand.
- 22" H x 15" x 15" (top) 18 lbs.

- |  |
|--|
| #WGMB9106 - Green Club Washer                                  |
| #WGMB9802 - Replacement Brush                                  |
| #WGMB9800 - Replacement Brush Kit (2 Brushes, Frame, & Screws) |

Reorder easily @ [www.wittekgolf.com](http://www.wittekgolf.com)



## PYRAMID SOLUTIONS



This pyramid builder conveniently loads from the top. It is fabricated out of galvanized steel with a choice of either steel or ABS plastic trays.

### METAL PYRAMID

- #76180 - Metal 55 Ball Pyramid Builder 3 lbs.
- #76181 - Metal 91 Ball Pyramid Builder 3.5 lbs.
- #76182 - Metal 140 Ball Pyramid Builder 4 lbs.
- #76183 - Metal 204 Ball Pyramid Builder 5 lbs.
- #76184 - Metal 285 Ball Pyramid Builder 6 lbs.

### METAL PYRAMID TRAY ONLY

- #76185 - Metal 55 Ball Pyramid Tray 1 lbs.
- #76186 - Metal 91 Ball Pyramid Tray 1.3 lbs.
- #76187 - Metal 140 Ball Pyramid Tray 1.7 lbs.
- #76188 - Metal 204 Ball Pyramid Tray 2 lbs.
- #76189 - Metal 285 Ball Pyramid Tray 3 lbs.

### PLASTIC PYRAMID TRAY ONLY

- #76190 - Plastic 55 Ball Pyramid Tray 0.50 lbs.
- #76191 - Plastic 91 Ball Pyramid Tray 0.75 lbs.
- #76192 - Plastic 140 Ball Pyramid Tray 1 lbs.
- #76193 - Plastic 204 Ball Pyramid Tray 1.25 lbs.

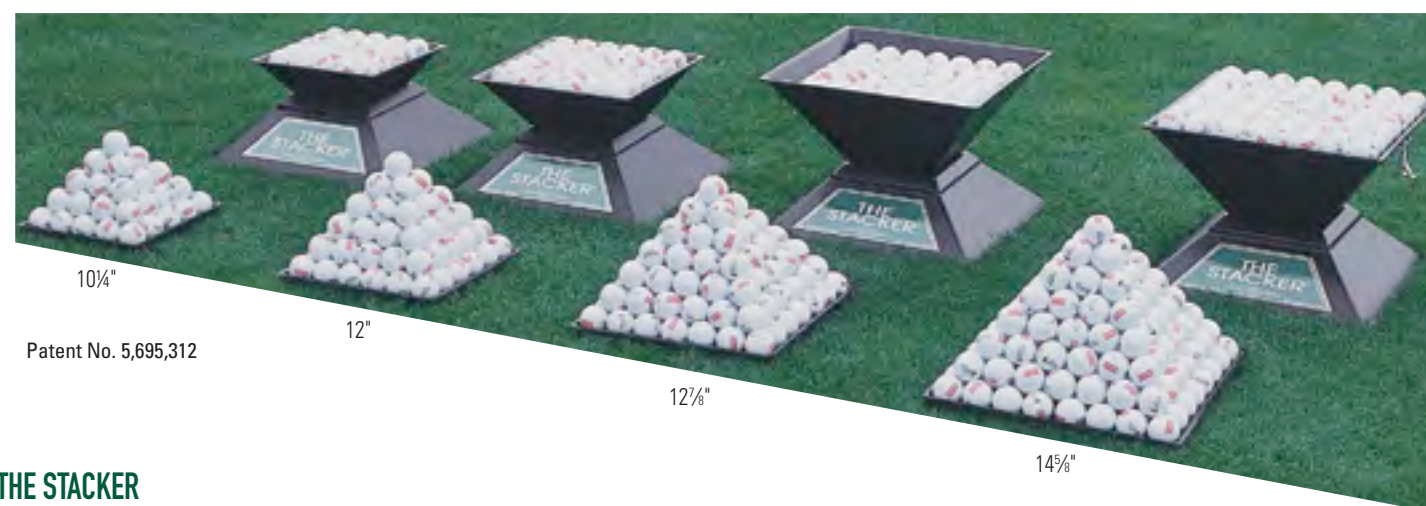

Patent No. 5,695,312

### THE STACKER

Enhance your course image. Create a clean and organized tee line while increasing labor efficiency. Ideal for special events! Fast and easy to use - simply pour balls into The Stacker, cover with tray and invert. Balls come out in a perfect pyramid every time. All kits include 15 trays. This style of pyramid stacker does not fit metal trays.

- #76159 - 204 Ball Stacker Kit
- #76158 - 204 Ball Tray Only
- #76163 - 204 Ball Stacker Only
- #76160 - 140 Ball Stacker Kit
- #76161 - 140 Ball Tray Only
- #76162 - 140 Ball Stacker Only

- #76165 - 91 Ball Stacker Kit
- #76166 - 91 Ball Tray Only
- #76167 - 91 Ball Stacker Only
- #76168 - 55 Ball Stacker Kit
- #76169 - 55 Ball Tray Only
- #76170 - 55 Ball Stacker Only

### FORE-N-ONE

The Fore-N-One is an innovative new way to make four different sized pyramids (55, 91, 140, and 204) from one pyramid builder. The Small Fore-N-One makes both 55 and 91 ball pyramids. Just select the tray size and load balls into the top of the Fore-N-One. Then remove the Fore-N-One, and you're done! Kit includes one top loading unit. Trays sold separately (refer to Stacker Ball Trays Only).

Fore-N-One Pyramid Builder 15 1/4" L x 15 1/4" W x 14" H (5 lbs.)  
Small Fore-N-One Pyramid Builder 12" L x 12" W x 13" H (3 lbs.)

- #76171 - Fore-N-One Pyramid Builder
- #76172 - Small Fore-N-One Pyramid Builder

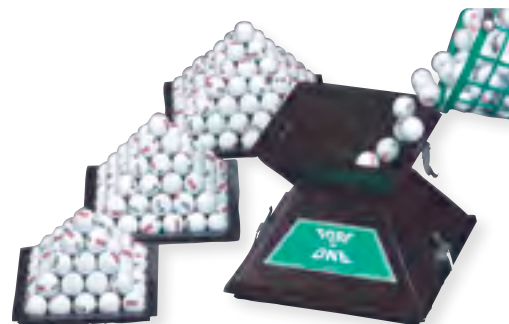

## TEE DIVIDERS

### EMPIRE DIVIDER

These dividers are self-standing and easily moveable. A bigger twist to our Classic Range Divider, the Empire Divider can be made from any of our recycled plastic colors, and has a large space for a custom logo or message in the middle!  
59 1/2" L x 10" D x 24" H (20 lbs.)

- #P060G - Green
- #P060BLK - Black
- #P060BRN - Brown
- #P060DRT - Driftwood
- #P060WN - Walnut
- #P060C - Custom

### CLASSIC RANGE DIVIDER

A moveable range divider that clearly delineates the hitting areas on the range. 14" H x 48" L 12 lbs.

- #P059AG - Green
- #P059ABLK - Black
- #P059ABRN - Brown
- #P059ADRT - Driftwood
- #P059AWN - Walnut
- #P059C - Custom

### TEE DIVIDERS/DIRECTIONAL ARROWS

#### RECYCLED PLASTIC FLAT ARROW

Size: 42" L x 3 1/2" W x 1 1/2" H (5 lbs.)

- #P051G - Green
- #P051BLK - Black
- #P051BRN - Brown
- #P051DRT - Driftwood
- #P051WN - Walnut
- #P051C - Custom

#### RECYCLED PLASTIC VERTICAL ARROW

Size: 42" L x 1 1/2" W x 3 1/2" H (5 lbs.)

- #P056G - Green
- #P056BLK - Black
- #P056BRN - Brown
- #P056DRT - Driftwood
- #P056WN - Walnut
- #P056CN - Custom



Logo Additional - Call to discuss custom options.



Color choices for all recycled plastic products

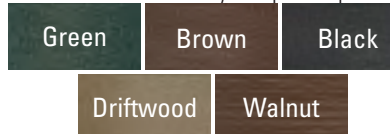

### COUNTRY CLUB TEE DIVIDER

- Long lasting polyethylene construction.
- UV stabilized to protect from fading.
- Comes with four 6" ground spikes.
- Custom colors available..

8" H x 52" L x 3" D 6 lbs.

#77715 - Hunter Green

### PRO 2000 TEE DIVIDER

- Long-lasting polyethylene construction.
- Built-in club rest holds up to four clubs.
- Holds beverage, keys, loose change and any size metal or plastic range pail.
- Designed for cement or grass tee areas.

30" H x 60" L x 13 3/4" D 25 lbs.

#77685 - Hunter Green

Use your terms @ [www.wittekgolf.com](http://www.wittekgolf.com)



# A-FRAME YARDAGE SIGNS



A-Frame signs are the best way to keep your customers informed. Our custom range yardage signs can be made with either permanent or interchangeable yardages and can include logos or other messages. Made of super durable laminated plastic our A-Frames are made to last and look great for many years. Let our expert design staff create a sign that is perfect for you. Clock additions are available to ensure everyone makes their tee time. Two standard sizes to choose from, but can be customized to your specifications. Colors available colors: green, yellow, blue, black, red and brown.

The following colors are available in only 1/2" White/Green/White Brown/White/Brown

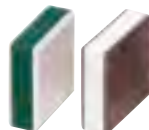

The following colors are available in both 1/2" and 3/4" Green/White/Green Blue/White/Blue Red/White/Red Black/White/Black Yellow/Black/Yellow

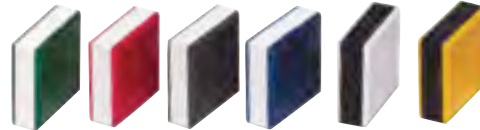

**Choose Your Size:**

While we have some stock sizes listed, if you need a sign bigger or smaller, we can make it!

**Choose Your Logo:**



Engraved (w/ or w/out colorfill)



Lexan



Clock

**Choose Tracks:**



2" Number Tracks

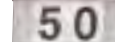

3" Number Tracks

**Choose your Targets:**



Pennant



Flag



Dot

## 17" W X 30" H



1/2" Thick

Give your golfers the yardages they need with these durable laminated plastic signs! Available single or double sided, with or without your logo or a clock. Yardage numbers and aluminum tracks are available in 2" and 3" sizes and are fully interchangeable. Weight 22 lbs.

**3 Yardages**

- #78450 Single Sided w/ 3 Yardages
- #78451 Double Sided w/ 3 Yardages

**4 Yardages**

- #78452 Single Sided w/ 4 Yardages
- #78453 Double Sided w/ 4 Yardages

Call for a quote on signs with clocks/logos!

## 22" W X 32" H



1/2" Thick

Give your golfers the yardages they need with these durable laminated plastic signs! Available single or double sided, with or without your logo or a clock. Yardage numbers and aluminum tracks are available in 2" and 3" sizes and are fully interchangeable. Weight 30 lbs.

**5 Yardages**

- #78454 Single Sided w/ 5 Yardages
- #78455 Double Sided w/ 5 Yardages

**6 Yardages**

- #78456 Single Sided w/ 6 Yardages
- #78457 Double Sided w/ 6 Yardages

**7 Yardages**

- #78458 Single Sided w/ 7 Yardages
- #78459 Double Sided w/ 7 Yardages

Call for a quote on signs with clocks/logos!



### Driving Range Yardage Sign With 12" Clock

Give your golfers the yardages they need with these durable laminated plastic signs! Available single or double sided, with or without your logo or a clock. Yardage numbers and aluminum tracks are available in 2" and 3" sizes and are fully interchangeable.

## 32" W X 40" H

3/4" Thick



**6 Yardages**

- #78460 Single Sided w/ 6 Yardages & 12" Clock
- #78461 Double Sided w/ 6 Yardages & 12" Clock

**8 Yardages**

- #78464 Single Sided w/ 8 Yardages & 12" Clock
- #78465 Double Sided w/ 8 Yardages & 12" Clock

Call for a quote on signs with clocks/logos!

Unlike other companies, our laminated plastic signs are all made in house. This means that they are fully customizable, and can be made in custom dimensions and engraved or Lexan logos, to meet your signage needs.

Call for a custom quote!





# RANGE MARKINGS

## ▶ 3½" DIAMETER STRIPED YARDAGE POLES

For your range or golf course. Ideal for Fairway Markers.

Striped yardage poles are 3½" in diameter for easy visibility. Comes with one 12" steel ground anchor for easy installation and removal. Marker inserts 1" below ground. Weight: 7-13 lbs.

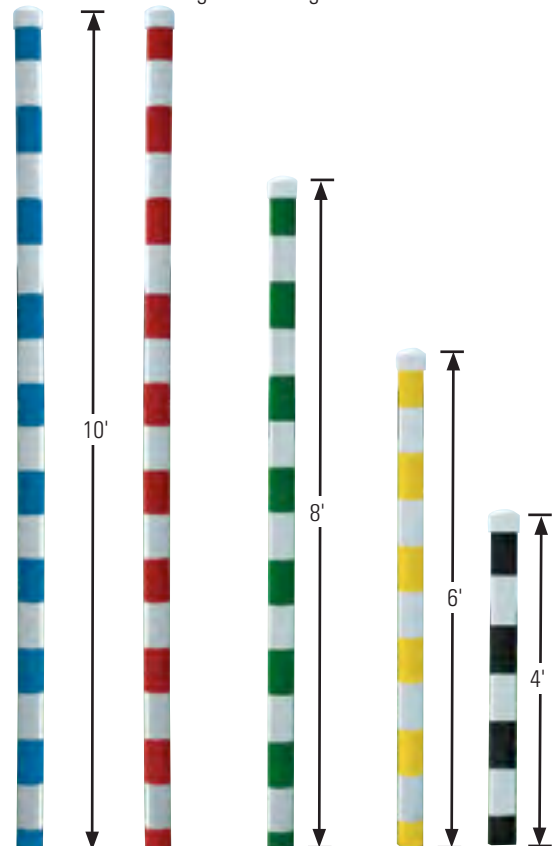

Add numerical suffix to item number for color choice:  
 -1 Black, -2 Blue, -3 Green, -4 Red, -5 Yellow, -6 Orange, -7 Plain/No Stripe

- #77265 - 4' Weight 6 lbs.
- #77270 - 6' Weight 9 lbs.
- #77275 - 8' Weight 11 lbs.
- #77280 - 10' Weight 13 lbs.

## ▶ METAL SLEEVE

In ground sleeve for yardage pole. 12"H x 4"D

#M-77-48



## ▶ WIND DIRECTION FLAG

Add a wind direction flag to your yardage poles. Complete with rod. (Does not fit the 5" diameter poles). Weight 0.5 lbs.

- #77260 - Black
- #77261 - Green
- #77262 - Red
- #77263 - Yellow
- #77264 - White
- #77266 - Blue
- #77267 - Orange
- #77268 - Purple

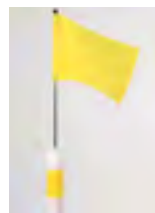

## ▶ 8' STRIPED YARDAGE POLES, 5" DIAMETER

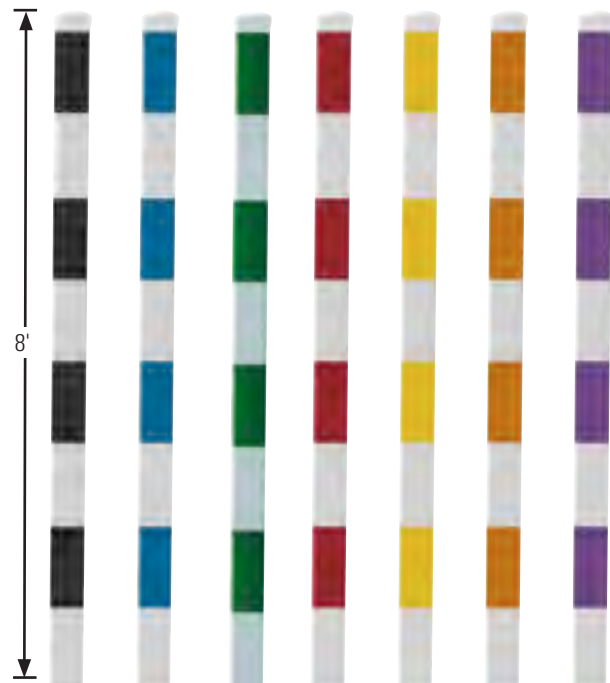

- #P075BLK - Black
- #P075B - Blue
- #P075G - Green
- #P075R - Red
- #P075Y - Yellow
- #P075O - Orange
- #P075P - Purple
- #P075PLN - Plain (13 lbs.)

## ▶ REFLECTIVE TAPE

#P076RT - 6" Wide



## ▶ HIGHLIGHT YOUR RANGE WITH THESE OVERSIZED FLAGS

We manufacture high quality oversized range flags. Easier to see at long distances, these 400 denier flags will last and last. All oversize flags are made Soft Pocket style.

- #401980 - Red
- #401981 - White
- #401982 - Yellow
- #401983 - Blue
- #401984 - Green
- #401985 - Black
- #401986 - Orange
- #401987 - Navy Blue
- #401988 - Gold
- #401989 - Purple

#P095LCX - Custom Checkered Flag

## ▶ SLEEVE

In ground sleeve for yardage pole 12" x 12" x 17" H Weight 12 lbs

#P075S



## ▶ FLAG EXTENSION PACKAGE

30" H Weight 1.2 lbs

#P075T

Flags sold separately



# VINYL GUARD<sup>®</sup> golf

## ▶ 2" DIAMETER FAIRWAY POLES & VINYL GUARD

- Extremely durable, factory-applied VinylGuard covering over a 2-inch diameter, 5-foot tall PVC pole
- Impervious to abrasion, UV sunlight, chemicals and the elements
- Will not tear, peel chip or fade – Shatterproof

#30-FM-2000B Black and White

Fairway post

#30-FM-2000R Red and White

Fairway post



## ▶ RANGE BANNERS

High visibility and affordability have made our range banners a popular addition to ranges across the country.

- Bold yardages (50 to 300 yards) on bright yellow or green nylon.
- Each banner is sewn to fit a PVC frame that you can build yourself, or try our easy to assemble frame kit.

Price - \$55.99 ea.

## ▶ VERTICAL RANGE BANNER

Size 48"H x 24"W (Vertical)  
Weight: .4 lbs.

## ▶ HORIZONTAL RANGE BANNER

Size 24"H x 48"W (Horizontal)  
Weight: .4 lbs.

Length	Yellow/Black	Green/White	Yellow/Black	Green/White
50 Yards	#31050V	#35050V	#31050H	#35050H
75 Yards	#31075V	#35075V	#31075H	#35075H
100 Yards	#31100V	#35100V	#31100H	#35100H
125 Yards	#31125V	#35125V	#31125H	#35125H
150 Yards	#31150V	#35150V	#31150H	#35150H
175 Yards	#31175V	#35175V	#31175H	#35175H
200 Yards	#31200V	#35200V	#31200H	#35200H
225 Yards	#31225V	#35225V	#31225H	#35225H
250 Yards	#31250V	#35250V	#31250H	#35250H
275 Yards	#31275V	#35275V	#31275H	#35275H
300 Yards	#31300V	#35300V	#31300H	#35300H

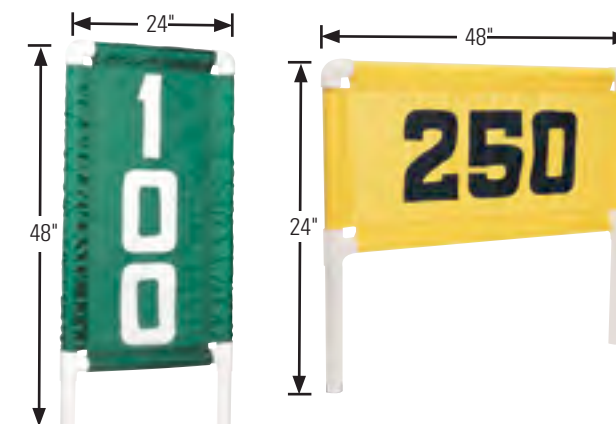

## ▶ RANGE BANNER FRAME KIT

Here's everything you need to build a frame for our Horizontal or Vertical Range Banners. Heavy-duty parts, drawing and instructions. Order one kit per banner.

#31000ST - \$99.99 ea.



Frame, tees and elbows ½" diameter. Ground anchors 10" long.

# RANGE MARKINGS

## ▶ SHORT GAME PRACTICE STICK

Give your golfers realistic targets to hit, while giving your maintenance crew ones that are easy to move! Made with a 5' tall, ½" flagstick and a durable spiked laminated plastic base. These targets are easy to see, easy to move and easy to add a flag on to at an unbeatable price! Please call for custom striping.

- #P100S10 - White Stick w/ Spiked Base
- #P100S11 - Yellow Stick w/ Spiked Base

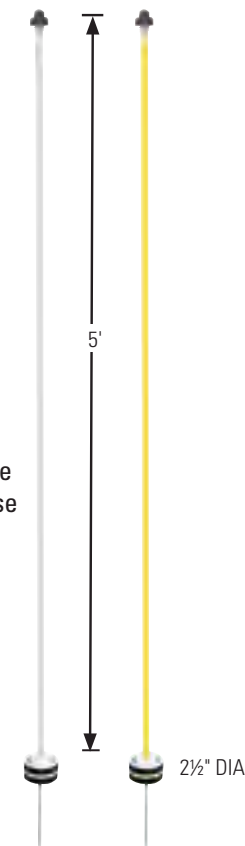



RANGE TARGETS



▶ THE GOLF TARGET

48" overall with a 32" graphic panel that gives your golfers an exciting target to aim at and hit! Featuring three adjustable angles of 30 degrees, 45 degrees and flat on the ground and an audible sound when hit on the center graphic! Constructed of UV-stable TPO plastic and weighing less than 25 lbs, it is both weather and water resistant and made in the U.S.A!  
Easily customize the insert with any art ready graphic by giving us a call!

- #GT25 – 25 yard target
- #GT50 – 50 yard target
- #GT75 – 75 yard target
- #GT100 – 100 yard target



▶ THE LITTLE CHIPPER

The perfect target for a budget friendly short game area! These drums come in red, white, blue and yellow and are the perfect way to add multiple targets to your range without breaking the bank!

- #77463 – Red drum
- #77464 – White drum
- #77465 – Blue drum
- #77466 – Yellow drum



▶ YARDAGE SIGN KITS

Mark your targets with these aluminum signs! Bolted to each barrel with a piece of 2" x 2" lumber on back.

- #77467 – 25 Yard Sign Kit
- #77468 – 50 Yard Sign Kit
- #77469 – 75 Yard Sign Kit
- #77470 – 100 Yard Sign Kit



▶ DELUXE CHIPPING TARGETS

These NEW range targets are perfect for ranges! Available in stock options of 25, 50, 75 yards and a bullseye option, all made from laminated plastic, these targets feature a built-in kickstand in back for easy mowing and movement. Give your guests these bright and durable targets to hit at so you can sell more range balls and keep them coming back!  
24" Diameter, Weight 10 lbs.

- #DCT25 – Yellow/Black 25
- #DCT50 – White/Black 50
- #DCT75 – White/Blue 75
- #DCTBULL – Red/White Bullseye
- #DCTCUST – Custom

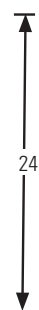

NEW in 2021



▶ RANGE TARGET NET

These fantastic targets are great for short game practice. Made using a sturdy Polybutylene frame with UV protected nylon netting and the bases are weighted for added stability. Weight 24 lbs.

- #79174 - Range Target Net 4' Diameter with yellow pads
- #79176 - Range Target Net 4' Diameter with red pads
- #79182 - Range Target Net 4' Diameter with red/white/blue pads
- #79181 - Range Target Net 4' Diameter with white pads
- #79180 - Range Target Net 4' Diameter with blue pads



- #79175 - Pack of 6 yellow accent pads for range target net
- #79177 - Pack of 6 red accent pads for range target net
- #79185 - Pack of 2 red 2 white and 2 blue accent pads for range target net
- #79184 - Pack of 6 white accent pads for range target net
- #79183 - Pack of 6 blue accent pads for range target net

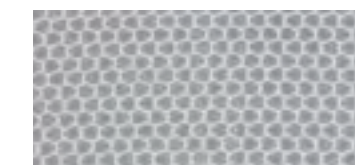

#P075RT - Reflective Tape Strip (3" W x 11.5" L)



# RANGE MARKINGS



### BELL SHAPED TARGETS

These bell shaped range targets are not only extremely durable, but extremely attractive! Mount the recycled plastic end posts into the ground and give your golfers a great looking target to hit at, that will last forever! Please specify color and number when ordering custom targets. 36"L x 4 1/2"D x 72"H (10 lbs.)

- #P081R - Red 100
- #P081W - White 150
- #P081B - Blue 200
- #P081Y - Yellow 250

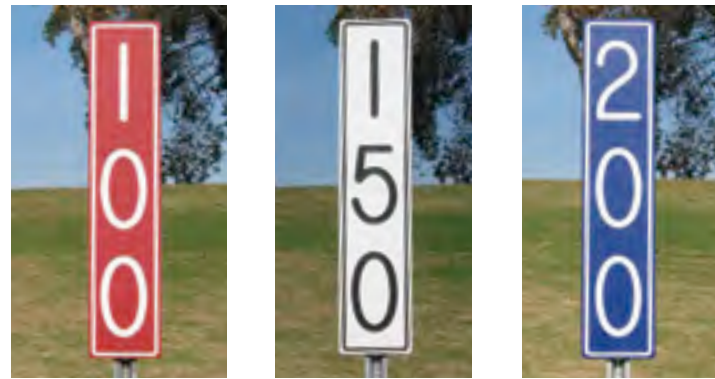

### VERTICAL YARDAGE MARKERS

Made using the same material as our horizontal yardage markers, these fantastic looking vertical yardage markers are virtually indestructible. Each marker measures 12" wide x 60" high and comes complete with a heavy gauge galvanized steel 8' post. Weight 26 lbs.

- #P0826R - Red 100
- #P0826W - White 150
- #P0826B - Blue 200
- #P0826Y - Yellow 250



### HORIZONTAL YARDAGE MARKERS

Made from 3/4" engraved laminated plastic, our oval markers measure 47" wide x 30" high and are super easy to see. Each unit comes with two 4" x 4" recycled plastic posts with spikes that push easily into the ground. Weight 55 lbs.

- #P083R - Red 100
- #P083W - White 150
- #P083B - Blue 200
- #P083Y - Yellow 250



### BULLS EYE MARKERS

Made using the same materials as our yardage markers shown above. These markers are 47" wide, 30" tall and come with two 4" x 4" recycled plastic posts. These markers are virtually indestructible! Weight 55 lbs.

#P083Target

# RANGE MARKINGS

### PRO 2000 VERTICAL YARDAGE MARKERS

For the Maximum in High Visibility. Molded plastic construction for long-lasting wear. Available in Green and Yellow. Comes with two 10' PVC ground anchors for easy installation. 55"H above ground. 12"W x 1.75"D. 10.60 lbs.



**EASY TO SEE FROM ANY DISTANCE!**

Yardage	Green/White	Yellow/Black
50 Yards	#77110	#77150
75 Yards	#77111	#77151
100 Yards	#77112	#77152
125 Yards	#77113	#77153
150 Yards	#77114	#77154
175 Yards	#77115	#77155
200 Yards	#77116	#77156
225 Yards	#77117	#77157
250 Yards	#77118	#77158
275 Yards	#77119	#77159

### PRO 2000 OVAL DISTANCE MARKERS

High visibility with long lasting polyethylene. Available in 2 sizes. UV stabilized to protect against fading. Comes with four 10" spikes and a metal in ground sleeve for mounting using a 2 x 4.

#### SMALL OVAL

Size 26"H x 31"W x 4"D Weight: 9.5 lbs.

Distance	Green/White	Yellow/Black
25 Yards	#77410	#77450
50 Yards	#77411	#77451
75 Yards	#77412	#77452
95 Yards	#77413	#77453

#### LARGE OVAL

Size 36"H x 47"W x 4"D Weight: 18 lbs.

Distance	Green/White	Yellow/Black
100 Yards	#77414	#77454
125 Yards	#77415	#77455
150 Yards	#77416	#77456
175 Yards	#77417	#77457
200 Yards	#77418	#77458
225 Yards	#77419	#77459
250 Yards	#77420	#77460
275 Yards	#77421	#77461
300 Yards	#77422	#77462



### Oval Marker Mounting Sleeve

Rectangular metal sleeve for oval yardage marker.

#M-77-07



### PRO 2000 OVAL BULLSEYE MARKERS

High visibility with long lasting polyethylene. Available in 2 sizes



#### SMALL OVAL

31"L x 4"W x 26"H (9 1/2 lbs.)

- #77423 - Green
- #77424 - Yellow

#### LARGE OVAL

47"L x 4"W x 36"H (18 lbs.)

- #77425 - Green
- #77426 - Yellow



## NEON RANGE SUPPLIES

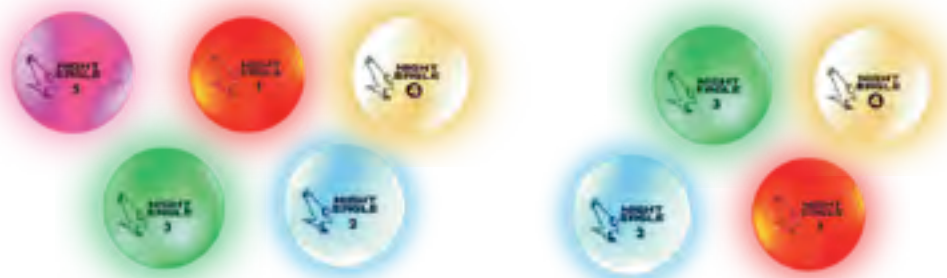

## ▶ LIGHT ACTIVATED LED BALLS

To activate you shine a strong light source, such as the light from your smartphone camera about 1/2 inch from the printed circle on the ball. Upon sensing the strong light, the computer will automatically turn on the LEDs. Once the LEDs are activated they will continue to emit light until another strong light is sensed. There is no timer inside our LED golf ball, once activated it will stay continuously lit until turned off. We do not recommend using our golf balls with newer thin faced drivers, Please use with irons only.

- #500275P – Pink Ball
- #500275G – Green Ball
- #500275W – White Ball
- #500275B – Blue Ball
- #500275R – Red Ball

## ▶ IMPACT ACTIVATED RANGE BALLS

Experience our 30 second LED range golf ball, perfect for events that require the golf ball to turn on for only a short period of time. Upon impact the range ball will turn on for 30 seconds and then turn off. Great for use with our LED range targets, hole in one contests, and other driving range activities. Internally powered using 2 CR2032 lithium batteries for up to 30-40 hours of use.

- #500175B – Blue Ball
- #500175G – Green Ball
- #500175W – White Ball
- #500175R – Red Ball

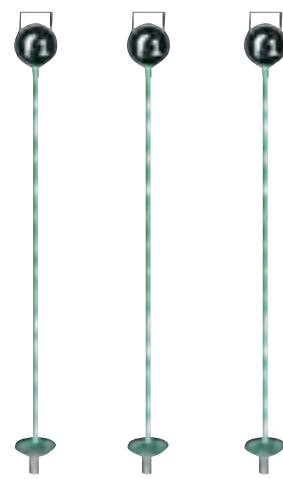

## ▶ NEON PRACTICE GREEN MARKER

Over 30 LED lights illuminate each flag stick and provide 7 different lighting options: steady on, color changing, blinking, in red, blue or green. 16 hour battery life is provided using the 3 AAA batteries that are included and easily replaceable. Please note: The flag stick is not waterproof and should be removed after use.

- #500300 – Neon Practice Green Markers



Lights up when hit with ball!

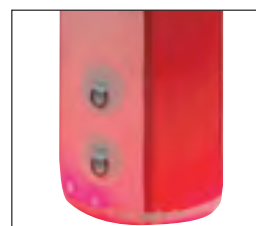

## ▶ 6' INFLATABLE TOWER TARGET

Interactive night time sports targets are incredibly entertaining and tons of fun! Our golf target system is designed to be anchored to grass. When hit using a golf ball or any other our inflatable target reacts with light to give visual feedback to the player. Each target comes with a SmartCore Power Puck that is super bright and makes the targets visible from up to 300 yards away:

- Flashes when hit
  - Rechargeable Lithium Powered
  - 8 hr Run Time
  - Multiple Color modes
  - Super Bright -
- Our targets are made with the highest grade of materials:
- Durable Vinyl Construction
  - Water Proof Design
  - Brandable for sponsors
  - 21" x 72" Design

Our targets can be purchased in three distinct colors: red/white, blue/white, and green/white. Each of the colors are specifically designed to complement each other and create a visibly stunning range.

- #500150B – 6' Blue/White Target
- #500150G – 6' Green/White Target
- #500150R – 6' Red/White Target

## NEON RANGE SUPPLIES



Lights up when hit with ball!

## ▶ 12' INFLATABLE SAUCER TARGET

Take golf entertainment to a whole new level! These interactive targets are designed to react with light when hit with a golf ball. Each target comes with a SmartCore Power Puck that is super bright and makes the targets visible from up to 300 yards away.

- Flashes when hit
  - Water Resistant
  - Rechargeable Lithium Powered
  - 8 hr Run Time
  - Multiple Color modes
- Smart targets are the way to supercharge your next golf outing and turn it into GOLF ENTERTAINMENT!
- Our targets are made with the highest grade of materials:
- Durable Vinyl Construction
  - Water Proof Design
  - Can be Floated
  - Brandable for sponsors
  - 12" x 60" Design
  - Tilts up for bullseye pattern.

You can purchase our targets in three distinct colors: red/white, blue/white, and green/white. Each of the colors are specifically designed to complement each other and create a visibly stunning range.

- #500250B – 12' Blue/White Target
- #500250G – 12' Green/White Target
- #500250R – 12' Red/White Target





# STARTER CLOCKS



Deluxe 18" Clock

12" Clock

### CLOCK-ON-POST



- Perfect for ranges or practice greens.
  - Comes with sturdy stand alone support post which can be secured with spikes.
  - Includes four ground spikes.
  - Features a 12" clock.
- 4"W x 36"H x 4"D (22 lbs.)

- #402580 - Black
- #402581 - Green
- #402582 - Brown
- #402583 - Driftwood
- #402584 - Walnut

### DELUXE CLOCK-ON-POST

Deluxe models feature 18" diameter atomic clock with built-in temperature and hydrometer gauges.

- 4"W x 48"H x 4"D (35 lbs.)
- #402590 - Black
  - #402591 - Green
  - #402592 - Brown
  - #402594 - Driftwood
  - #402592WN - Walnut



18" Atomic Clock

12" Clock

### REPLACEMENT CLOCKS

- Weather-resistant.
  - Two models:
- 12" diameter Easel Replacement Clock.  
18" diameter Deluxe Easel Atomic. Clock features built in temperature and hydrometer gauges.

12" Clock, White 1.5 lbs.

#77322

18" Atomic Clock, Silver 4 lbs.

#77323



12" Easel Clock

18" Deluxe Easel Clock

### EASEL CLOCKS (SINGLE-SIDED)

- A striking addition to #1 and #10 tee boxes and clubhouse.
- Easel clock features a 12" clock.
- Deluxe model features 18" diameter atomic clock with built-in temperature and hydrometer gauges.

Easel Clock- 16"W x 23"H (17 lbs.)

#402585

Deluxe Easel Clock- 28"W x 22"H (42 lbs.)

#402595



### PRO 2000 STARTER CLOCK/SIGN HOLDER

A clock or sign on both sides will keep your golfers informed and on time! Built-in handle allows for easy movement. Sign holders are sold double sided without signs included. Clock holders are sold double sided including 2, outdoor/all-weather clocks that run on one AA battery (not included).

18 1/2"W x 29"H (16 lbs.)

#77325 - Black Pro 2000 Starter Clock (Clock on both sides)

#77327 - Green Pro 2000 Starter Clock (Clock on both sides)

#77285 - Black Pro 2000 Sign Holder (Double sided/signs sold separate)

#77286 - Green Pro 2000 Sign Holder (Double Sided/signs sold separate)

#77322 - 12" Clock Only



### ECONOMY NETTING

Made of 1" mesh knitted 100% polypropylene.  
Break strength: 50 lbs.  
Burst strength: 150 lbs.

#### SPECIFICATIONS

Fiber: 100% Polypropylene

Color: Black

Construction: Knitted

Break Strength: 50 lbs.

Burst Strength: 150 lbs.

UV Stabilizer: Carbon Black

Average field life: 10-12 years.

Approx. Percent Solid: 8%

#79300 6 1/2' x 150'.  
Weight: 10 lbs.

#79301 12 1/2' x 150'.  
Weight: 20 lbs.

#79302 25' x 100'.  
Weight: 27 lbs.

#79303 25' x 150'.  
Weight: 40 lbs.

### BALL BARRIER NETTING

Our most durable 1" mesh knitted netting that stops 'off course' balls. Featuring all new break strengths of 75 lbs. and 225 lbs. burst strength! Long life. Lasts an average of 10-15 years. Custom sizes available. Heights up to 50' in one piece. 100% polypropylene. Will not rot or mildew.

#### SPECIFICATIONS

Fiber: 100% Polypropylene

Color: Black

Construction: Knitted

Break Strength: 75 lbs.

Burst Strength: 225 lbs.

UV Stabilizer: Carbon Black

Average Field Life: 10 to 15 Years

Approx. Percent Solid: 10%

#79001 Netting - 6 1/2' x 150'  
Weight: 20 lbs.

#79002 Netting - 12 1/2' x 150'  
Weight: 40 lbs.

#79003 Netting - 25' x 100'  
Weight: 50 lbs.

#79004 Netting - 25' x 150'  
Weight: 75 lbs.

#79006 Netting - 37 1/2' x 150'  
Weight: 125 lbs.

#79005 Netting - 50' x 150'  
Weight: 150 lbs.

### SYSTEM II NETTING (ROPE BORDER)

System II is found on more golf facilities than any other net. Rope bordered to your exact pole and cable centers makes snap hook installation a breeze. System II netting will not turn gray, rot or mildew. 10 year warranty. Complete packages including net, hardware and poles are available.

#### BORDERING COMPONENTS AND ATTACHMENT TWINE

3/8" diameter braided polypropylene cover over MFP parallel core 2840 lb. test. Used for netting perimeter, horizontal windlines and vertical riblines. Attachment twine #42 braided black polyester 440 lb. tensile strength. 5/16" snap hooks are then used to attach netting panels to all support cables on 2' centers. System II net panels are hand bordered to your exact dimensions.

#### SPECIFICATIONS

Product: 1" Mesh golf range netting

Fiber: Hi-tenacity polyester

Color: Black

Construction: Long stitch, knotless join

Break Strength: 100 lbs.

Burst Strength: 300 lbs.

UV Stabilizer: Impregnated

Average Field Life: 10 to 15 Years

Approx. Percent Solid: 8%

#79050

**CALL FOR HARDWARE PRICING/ PACKAGES**



DIY Rolls or custom built panels are easier than ever before!  
Shade Fabrics: Different shade values from 60% to 96% screens and colors available. We even have 100% blockage vinyl!  
Privacy Cloth: Up to 100% blockage  
These fabrics can be as low as \$1 per square foot. Give us a call today for a free, no obligation quote!



Reorder easily @ [www.wittekgolf.com](http://www.wittekgolf.com)



# PRACTICE NETS & CAGES

for Indoor or Outdoor Use



## ▶ POWER CAGE

New and improved for easy assembly and longer life. Ideal for golf shops and outdoor practice areas. A built-in double hitting wall withstands the strongest drives.

- Self standing cage assembles in minutes.
- Durable, lexan plastic posts and fittings snap together. No tools or hardware needed.
- One piece netting made of the finest 7/8" hi-tenacity black polyester. UV treated for outdoor use.
- Easy to assemble. Netting velcros to the frame.
- Diamond braid polyester rope cross members add stability and maximize wind-load protection.
- Includes 36" x 36" target.
- 10'H x 10'W x 10'D. Weight: 80 lbs.

Ships with UPS in 2 boxes.

#79150



See pages 26-29 for mats and ball trays.

## ▶ BAFFLE NETS

Don't have room for a full cage? Try our all nylon baffle nets. This is the same netting on the inside of our golf cages. We also specialize in custom sizes.

#CBT-4 - 4½' x 4½' Weight: 2 lbs. .

#CBT-9 - 10' x 9' Weight: 4 lbs.



## ▶ 7' X 7' SELF STANDING NET

The perfect warm up net for a low traffic area!

#JR189 - 7' x 7' Hitting Target .

# PRACTICE NETS & CAGES

for Indoor or Outdoor Use



## ▶ W SERIES PRACTICE NET

Accommodate two practicing golfers. Specially treated for outdoor use.

- Net features top, sides, and back constructed of extra heavy knotless nylon.
- Black net comes with a rope border and 10'x20' baffle.
- 10'H x 20'W by 12' deep.
- Weight: 28 lbs. Ships UPS.

#W-1220 - Netting & Baffles Only

Frame not included.



## ▶ REPLACEMENT TARGET FOR POWER CAGE

Heavy-duty 36" x 36" black target made of impact netting. Includes two 5' ropes to secure to framework. Weight 3 lbs.

#79151



## ▶ HITTING TARGETS

Vinyl Targets, 18oz. black vinyl bulls eye sewn onto a white scrim material- complete with attaching ropes.

#79152 - 5' x 5' Hitting Target Weight 3 lbs.

#79153 - 10' x 10' Hitting Target Weight 5 lbs.

**We specialize in custom made nets – Give us a call today!**

Nets to fit any space, indoor or out. Nets are available for all forms of recreational use.

Send us your specifications and we'll be happy to give you an estimate.





### Why choose us?

- Made in America – With American products.
- Each order is truly custom and treated that way – Each flag is hand cut and hand sewn, based on how YOU order.
- Quicker production times than the competition and a 3 day or less “in transit” to 38 of the 50 United States.
- Multiple locations and multiple product lines with over 50 employees to ensure the same high-quality customer service that you’ve come to expect.

### What makes our flags flag different?

See for yourself:



#### 1/8" Stitch MFS

- Sews tube permanently into flag material
- MFS constructed of darker materials prevents the material around the tube from discoloring

#### Zig Zag Stitch (Zig Zag Stitches)

- Added strength & security on every flag

#### Bar Tack (3/8")

- Extends the life of a flag

#### Bar Tack (3/8")

- Reinforcement of the tube's stitches that attaches it to the flag

#### 1/2" Double Needle Stitches ( Dash Patterned Stitches)

- Resists stretching
- Ensures the flag stitching won't unravel as easy as others do

#### 1/2" Border Tape

- "Frames" the flag
- Strengthens the flag edges and extends the life of the flag

### Mounting Options: Multiple options so you can have the right flag, for the right time!

- Plastic Tube: The same tube you've always used just got better! Now featuring a hexagon shape for added strength, these tubes resist the warping and cracking caused by long term use.
- Soft Tube: Used in place of plastic tubes, they are great for reducing noise on the green and even better for tournaments where the flags from the course may be used as give a ways or trophies following the round! Soft tubed flags are also easily framed.
- 3-Hole Grommet: Below, you'll see a traditional 3-hole grommet strip in comparison to a covered grommet strip. What's the difference? The covered grommet strip features extra fabric that wraps around the exterior of the traditional grommet strip to add a slightly more "modern" look to the timeless classic. This allows for material flag saver to be added! Grommet flags make for excellent trophy or souvenir flags as well!
- Tubeless: The perfect flag for pro shop, trophy or award flags!



Plastic Tube



Soft Tube



3-Hole Grommet



Tubeless

### Material Flag Saver (MFS): Our MFS not only adds a unique feature to your flags, but it extends the life of a flag by blocking & hiding the dirt that can accumulate from months of use on the course!

- Nylon Material Flag Saver: Available in all our stock fabrics and colors.
  - Simply add FPTM-Color to your order! Colors available: Augusta (AUG), Black (BLK), Custom (CUSTOM), Maroon (MRN), Navy (Navy), Red (RED).
- Reflective Material Flag Saver: Our reflective material flag saver works great with range finders and is a great alternative to the traditional reflectors added into or on top of the flagstick! Made from the same industrial material used on safety vests and jackets.
  - Simply add FPRTM to your order!
- Vinyl Material Flag Saver: Specially formulated to resist fading from sun exposure and resist bacteria growth!
  - Simply add FPVTM-Color to your order! Colors available: Black (BLK), Green (GRN), Clear (CLR), Red (RED), Royal (RYL), White (WHT), Yellow (YLW).



Nylon MFS

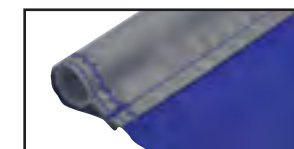

Reflective MFS



Vinyl MFS

### Border Options: Three options to make your course's flags fly above the rest!

- Standard Hem: Constructed with double needle and zig zag stitching along with extra tack strips to ensure a longer life for your flags!
  - Our standard hem comes standard on all of our flags, unless you tell us differently!
- Merrow Border: Constructed of special, tightly-sewn thread adding durability to your flag while also adding a contrasting feature to compliment your logo
  - Simply add FPRTM to your order!
- Border Tape: Available in all of our standard fabrics and colors for a more attractive appearance and a reinforced border with the same double needle, zig zag and tack strip stitching!
  - Simply add FP-BT to add border tape to a regulation flag order, FP-BTPG to add border tape to a putting green flag order!



Standard Hem



Border Tape

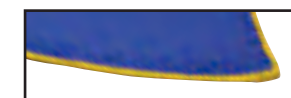

Merrow Border

See your invoices/statements @ [www.wittekgolf.com](http://www.wittekgolf.com)



## ▶ YOUR FLAGS – YOUR WAY

We offer a wide variety of 400 denier fabric choices! Your course deserves the highest quality and longest lasting equipment! 400 denier fabric can be used for plain flags, embroidery, screen print and even the border tape, MFS, checkers and custom patterns! If you think you need 200 denier for your course, please give us a call and we can help! For dye sublimated flags, other materials are needed.

400 Denier Nylon						200 Denier Nylon				
White	Black	Royal	Augusta	Red	Yellow	Gold	Orange	Navy Blue	Pink	Purple
White	Black	288	356	201	Yellow	1235	Orange	Navy Blue	Pink	Purple
Sublimation Poly		2 Ply Woven Poly		Poly/Cotton						
White	White	White	White	White	White	White	White	White	White	White

## ▶ EMBROIDERY

Beautiful, yet durable. Combine our 400 denier material, reinforced flag tube and your custom embroidered logo to create a flag that both you and your players can appreciate, round after round. We were the first to add the beauty and texture of thread to a golf flag, and have been doing it for thirty seven years. If you don't see the flag you would like, don't hesitate to give us a call as we can make any flag for any occasion, any time!



## ▶ SCREEN PRINT

Beautiful yet competitively priced. Our screen print process transfers your graphics onto our durable nylon fabric, creating a flag that is an exact match to your specs and sure to impress! Screen printed flags are a great way to ensure your flag will be flying on days when the wind isn't blowing. If you don't see the flag you would like, don't hesitate to give us a call as we can make any flag for any occasion, any time!



## ▶ DYE SUBLIMATION

The perfect tournament flag has never been easier to order! Great for when you need a lot of decoration in only a small amount of space, or when each hole's flag has a different design! While these flags do not carry the same warranty as our other flags do, we have several customers that have flown them for just as long as a standard flag without any issues! Available with spot sublimation or full bleed sublimation! Great for flags with four or more colors. Use item number #FPDSUB to order all sizes of dye sublimated flags!



## ▶ TROPHY FLAGS

Great for autographing for a number of occasions! Our trophy flags are made of 600 denier polyester featuring the traditional 3 hole grommet strip, including a permanent autographing pen and a clear tubular case for protection and easy handling. Smaller logos on trophy flags (7"x7" or 20K stitches) provide for ample autographing space. Please contact a sales representative for more information on how we can make your event even more memorable!



## ▶ CLUBHOUSE FLAGS

Does your clubhouse need a unique, one of a kind flag to make a lasting impression? Look no further! Each flag is made to order in any size, using your choice of embroidery, screen print, applique or a combination depending on your course's needs. Please contact a sales representative for more information on how we can make your clubhouse stand out from the rest!

<p>3ft x 5ft Applique Flag Front Side</p>	<p>3ft x 5ft Applique/Embroidery Combo Flag Front Side</p>
<p>4ft x 6ft Applique Flag Front Side</p>	



# 14" X 20" EMBROIDERED FLAGS 400 DENIER



Plastic Tube



Soft Tube









3-Hole Grommet

## ▶ EMBROIDERED SOLID FLAGS – 400 DENIER

Color	Tubed	Soft Pocket	3-Hole Grommet
 Red	#FPE14-R	#FPE14-R-SP	#FPE14-R-3H
 Blue	#FPE14-B	#FPE14-B-SP	#FPE14-B-3H
 Orange	#FPE14-O	#FPE14-O-SP	#FPE14-O-3H
 White	#FPE14-W	#FPE14-W-SP	#FPE14-W-3H
 Green	#FPE14-G	#FPE14-G-SP	#FPE14-G-3H
 Gold	#FPE14-GLD	#FPE14-GLD-SP	#FPE14-GLD-3H
 Yellow	#FPE14-Y	#FPE14-Y-SP	#FPE14-Y-3H
 Black	#FPE14-BLK	#FPE14-BLK-SP	#FPE14-BLK-3H
 Navy Blue	#FPE14-NB	#FPE14-NB-SP	#FPE14-NB-3H
 Purple	#FPE14-P	#FPE14-P-SP	#FPE14-P-3H
 Pink	#FPE14-PNK	#FPE14-PNK-SP	#FPE14-PNK-3H









## ▶ EMBROIDERED HANDLE AND BORDER – 400 DENIER

Color	Tubed	Soft Pocket	3-Hole Grommet
 Red/Black Border	#FPE14-R-BLK	#FPE14-R-BLK-SP	#FPE14-R-BLK-3H
 White/Black Border	#FPE14-W-BLK	#FPE14-W-BLK-SP	#FPE14-W-BLK-3H
 White/Green Border	#FPE14-W-G	#FPE14-W-G-SP	#FPE14-W-G-3H
 Yellow/Black Border	#FPE14-Y-BLK	#FPE14-Y-BLK-SP	#FPE14-Y-BLK-3H
 Yellow/Green Border	#FPE14-Y-G	#FPE14-Y-G-SP	#FPE14-Y-G-3H
 Blue/Black Border	#FPE14-B-BLK	#FPE14-B-BLK-SP	#FPE14-B-BLK-3H







## ▶ EMBROIDERED MERROW BORDER – 400 DENIER

Color	Tubed	Soft Pocket	3-Hole Grommet
 Red/Black Border	#FPE14M-R-BLK	#FPE14M-R-BLK-SP	#FPE14M-R-BLK-3H
 White/Black Border	#FPE14M-W-BLK	#FPE14M-W-BLK-SP	#FPE14M-W-BLK-3H
 White/Green Border	#FPE14M-W-G	#FPE14M-W-G-SP	#FPE14M-W-G-3H
 Yellow/Black Border	#FPE14M-Y-BLK	#FPE14M-Y-BLK-SP	#FPE14M-Y-BLK-3H
 Yellow/Green Border	#FPE14M-Y-G	#FPE14M-Y-G-SP	#FPE14M-Y-G-3H
 Blue/Black Border	#FPE14M-B-BLK	#FPE14M-B-BLK-SP	#FPE14M-B-BLK-3H

## ▶ EMBROIDERED LASER CUT CHECKERED WITH WINDOW- 400 DENIER







Color	Tubed	Soft Pocket	3-Hole Grommet
 Black / White Checks	#FLCE14-BLK-W	#FLCE14-BLK-W-SP	#FLCE14-BLK-W-3H
 Black / Yellow Checks	#FLCE14-BLK-Y	#FLCE14-BLK-Y-SP	#FLCE14-BLK-Y-3H
 Blue / White Checks	#FLCE14-B-W	#FLCE14-B-W-SP	#FLCE14-B-W-3H
 Red / White Checks	#FLCE14-R-W	#FLCE14-R-W-SP	#FLCE14-R-W-3H
 Green /White Checks	#FLCE14-G-W	#FLCE14-G-W-SP	#FLCE14-G-W-3H

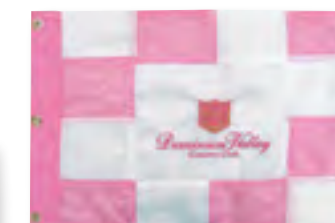
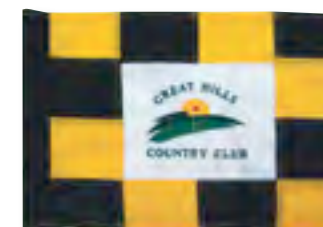

## ▶ EMBROIDERED SEWN CHECKERED WITH WINDOW- 400 DENIER



Color	Tubed	Soft Pocket	3-Hole Grommet
 Black / White Checks	#FCE14-BLK-W	#FCE14-BLK-W-SP	#FCE14-BLK-W-3H
 Black / Yellow Checks	#FCE14-BLK-Y	#FCE14-BLK-Y-SP	#FCE14-BLK-Y-3H
 Blue / White Checks	#FCE14-B-W	#FCE14-B-W-SP	#FCE14-B-W-3H
 Red / White Checks	#FCE14-R-W	#FCE14-R-W-SP	#FCE14-R-W-3H
 Green /White Checks	#FCE14-G-W	#FCE14-G-W-SP	#FCE14-G-W-3H





# 14" X 20" SCREEN PRINTED FLAGS 400 DENIER



Plastic Tube



Soft Tube



3-Hole Grommet

## ▶ SCREEN PRINTED SOLID FLAGS – 400 DENIER

Color	Tubed	Soft Pocket	3-Hole Grommet
Red	#FPS14-R	#FPS14-R-SP	#FPS14-R-3H
Blue	#FPS14-B	#FPS14-B-SP	#FPS14-B-3H
Orange	#FPS14-O	#FPS14-O-SP	#FPS14-O-3H
White	#FPS14-W	#FPS14-W-SP	#FPS14-W-3H
Green	#FPS14-G	#FPS14-G-SP	#FPS14-G-3H
Gold	#FPS14-GLD	#FPS14-GLD-SP	#FPS14-GLD-3H
Yellow	#FPS14-Y	#FPS14-Y-SP	#FPS14-Y-3H
Black	#FPS14-BLK	#FPS14-BLK-SP	#FPS14-BLK-3H
Navy Blue	#FPS14-NB	#FPS14-NB-SP	#FPS14-NB-3H
Purple	#FPS14-P	#FPS14-P-SP	#FPS14-P-3H
Pink	#FPS14-PNK	#FPS14-PNK-SP	#FPS14-PNK-3H



## ▶ SCREEN PRINTED HANDLE AND BORDER – 400 DENIER

Color	Tubed	Soft Pocket	3-Hole Grommet
Red/Black Border	#FPS14-R-BLK	#FPS14-R-BLK-SP	#FPS14-R-BLK-3H
White/Black Border	#FPS14-W-BLK	#FPS14-W-BLK-SP	#FPS14-W-BLK-3H
White/Green Border	#FPS14-W-G	#FPS14-W-G-SP	#FPS14-W-G-3H
Yellow/Black Border	#FPS14-Y-BLK	#FPS14-Y-BLK-SP	#FPS14-Y-BLK-3H
Yellow/Green Border	#FPS14-Y-G	#FPS14-Y-G-SP	#FPS14-Y-G-3H
Blue/Black Border	#FPS14-B-BLK	#FPS14-B-BLK-SP	#FPS14-B-BLK-3H



## ▶ SCREEN PRINTED MERROW BORDER – 400 DENIER

Color	Tubed	Soft Pocket	3-Hole Grommet
Red/Black Border	#FPS14M-R-BLK	#FPS14M-R-BLK-SP	#FPS14M-R-BLK-3H
White/Black Border	#FPS14M-W-BLK	#FPS14M-W-BLK-SP	#FPS14M-W-BLK-3H
White/Green Border	#FPS14M-W-G	#FPS14M-W-G-SP	#FPS14M-W-G-3H
Yellow/Black Border	#FPS14M-Y-BLK	#FPS14M-Y-BLK-SP	#FPS14M-Y-BLK-3H
Yellow/Green Border	#FPS14M-Y-G	#FPS14M-Y-G-SP	#FPS14M-Y-G-3H
Blue/Black Border	#FPS14M-B-BLK	#FPS14M-B-BLK-SP	#FPS14M-B-BLK-3H

## ▶ SCREEN PRINTED LASER CUT CHECKERED WITH WINDOW- 400 DENIER



Color	Tubed	Soft Pocket	3-Hole Grommet
Black / White Checks	#FLCS14-BLK-W	#FLCS14-BLK-W-SP	#FLCS14-BLK-W-3H
Black / Yellow Checks	#FLCS14-BLK-Y	#FLCS14-BLK-Y-SP	#FLCS14-BLK-Y-3H
Blue / White Checks	#FLCS14-B-W	#FLCS14-B-W-SP	#FLCS14-B-W-3H
Red / White Checks	#FLCS14-R-W	#FLCS14-R-W-SP	#FLCS14-R-W-3H
Green /White Checks	#FLCS14-G-W	#FLCS14-G-W-SP	#FLCS14-G-W-3H



## ▶ SCREEN PRINTED SEWN CHECKERED WITH WINDOW – 400 DENIER



Color	Tubed	Soft Pocket	3-Hole Grommet
Black / White Checks	#FSE14-BLK-W	#FSE14-BLK-W-SP	#FSE14-BLK-W-3H
Black / Yellow Checks	#FSE14-BLK-Y	#FSE14-BLK-Y-SP	#FSE14-BLK-Y-3H
Blue / White Checks	#FSE14-B-W	#FSE14-B-W-SP	#FSE14-B-W-3H
Red / White Checks	#FSE14-R-W	#FSE14-R-W-SP	#FSE14-R-W-3H
Green /White Checks	#FSE14-G-W	#FSE14-G-W-SP	#FSE14-G-W-3H





# 14" X 20" PLAIN FLAGS 400 DENIER



## PLAIN FLAGS - 400 DENIER

Color	Tubed	Soft Pocket	3-Hole Grommet
Red	#FP14-R	#FP14-R-SP	#FP14-R-3H
Blue	#FP14-B	#FP14-B-SP	#FP14-B-3H
Orange	#FP14-O	#FP14-O-SP	#FP14-O-3H
White	#FP14-W	#FP14-W-SP	#FP14-W-3H
Green	#FP14-G	#FP14-G-SP	#FP14-G-3H
Gold	#FP14-GLD	#FP14-GLD-SP	#FP14-GLD-3H
Yellow	#FP14-Y	#FP14-Y-SP	#FP14-Y-3H
Black	#FP14-BLK	#FP14-BLK-SP	#FP14-BLK-3H
Navy Blue	#FP14-NB	#FP14-NB-SP	#FP14-NB-3H
Purple	#FP14-P	#FP14-P-SP	#FP14-P-3H
Pink	#FP14-PNK	#FP14-PNK-SP	#FP14-PNK-3H



## PLAIN HANDLE AND BORDER - 400 DENIER

Color	Tubed	Soft Pocket	3-Hole Grommet
Red/Black Border	#FP14-R-BLK	#FP14-R-BLK-SP	#FP14-R-BLK-3H
White/Black Border	#FP14-W-BLK	#FP14-W-BLK-SP	#FP14-W-BLK-3H
White/Green Border	#FP14-W-G	#FP14-W-G-SP	#FP14-W-G-3H
Yellow/Black Border	#FP14-Y-BLK	#FP14-Y-BLK-SP	#FP14-Y-BLK-3H
Yellow/Green Border	#FP14-Y-G	#FP14-Y-G-SP	#FP14-Y-G-3H
Blue/Black Border	#FP14-B-BLK	#FP14-B-BLK-SP	#FP14-B-BLK-3H



Border Tape

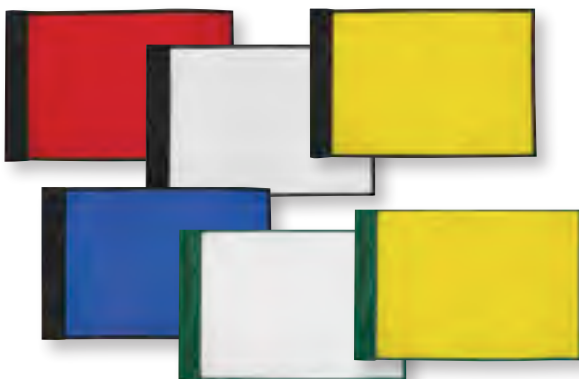

## PLAIN MERROW BORDER FLAGS - 400 DENIER

Color	Tubed	Soft Pocket	3-Hole Grommet
Red/Black Border	#FP14M-R-BLK	#FP14M-R-BLK-SP	#FP14M-R-BLK-3H
White/Black Border	#FP14M-W-BLK	#FP14M-W-BLK-SP	#FP14M-W-BLK-3H
White/Green Border	#FP14M-W-G	#FP14M-W-G-SP	#FP14M-W-G-3H
Yellow/Black Border	#FP14M-Y-BLK	#FP14M-Y-BLK-SP	#FP14M-Y-BLK-3H
Yellow/Green Border	#FP14M-Y-G	#FP14M-Y-G-SP	#FP14M-Y-G-3H
Blue/Black Border	#FP14M-B-BLK	#FP14M-B-BLK-SP	#FP14M-B-BLK-3H

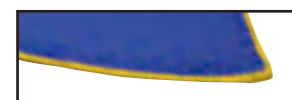

Merrow Border



## PLAIN LASER CUT CHECKERED FLAGS - 400 DENIER

Our cut and stitch applique process uses the same high quality 400 denier nylon and stitching process as our regular flags. Checkered flags are easily recognizable and are a great way to identify daily pin placements. Logos can be added to a center "window" by either silk screen or embroidery.

**Call for Custom Colors!**

Color	Tubed	Soft Pocket	3-Hole Grommet
Black / White Checks	#FPLC14-BLK-W	#FPLC14-BLK-W-SP	#FPLC14-BLK-W-3H
Black / Yellow Checks	#FPLC14-BLK-Y	#FPLC14-BLK-Y-SP	#FPLC14-BLK-Y-3H
Blue / White Checks	#FPLC14-B-W	#FPLC14-B-W-SP	#FPLC14-B-W-3H
Red / White Checks	#FPLC14-R-W	#FPLC14-R-W-SP	#FPLC14-R-W-3H
Green /White Checks	#FPLC14-G-W	#FPLC14-G-W-SP	#FPLC14-G-W-3H



## PLAIN SEWN CHECKERED FLAGS - 400 DENIER

Color	Tubed	Soft Pocket	3-Hole Grommet
Black / White Checks	#FPC14-BLK-W	#FPC14-BLK-W-SP	#FPC14-BLK-W-3H
Black / Yellow Checks	#FPC14-BLK-Y	#FPC14-BLK-Y-SP	#FPC14-BLK-Y-3H
Blue / White Checks	#FPC14-B-W	#FPC14-B-W-SP	#FPC14-B-W-3H
Red / White Checks	#FPC14-R-W	#FPC14-R-W-SP	#FPC14-R-W-3H
Green /White Checks	#FPC14-G-W	#FPC14-G-W-SP	#FPC14-G-W-3H

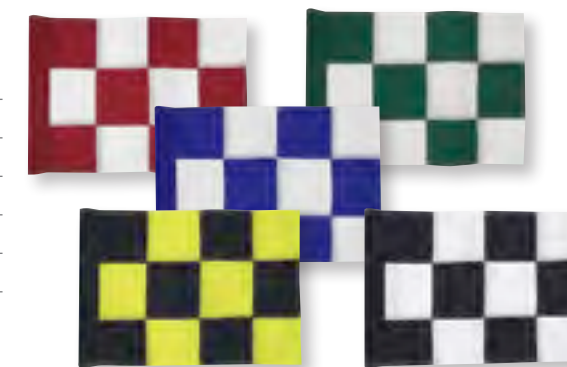

## APPLIQUE NUMBERED FLAGS 400 DENIER

Sold In Sets Of 9 Only.

Color	Tube Lock 1-9	Tube Lock 10-18	Soft Pocket 1-9	Soft Pocket 10-18	Grommet 1-9	Grommet 10-18
White / Black Numbers	#FP14AN9-W-BLK	#FP14AN18-W-BLK	#FP14AN9-W-BLK-SP	#FP14AN18-W-BLK-SP	#FP14AN9-W-BLK-3H	#FP14AN18-W-BLK-3H
Blue / White Numbers	#FP14AN9-B-W	#FP14AN18-B-W	#FP14AN9-B-W-SP	#FP14AN18-B-W-SP	#FP14AN9-B-W-3H	#FP14AN18-B-W-3H
Red / White Numbers	#FP14AN9-R-W	#FP14AN18-R-W	#FP14AN9-R-W-SP	#FP14AN18-R-W-SP	#FP14AN9-R-W-3H	#FP14AN18-R-W-3H
Yellow / Black Numbers	#FP14AN9-Y-BLK	#FP14AN18-Y-BLK	#FP14AN9-Y-BLK-SP	#FP14AN18-Y-BLK-SP	#FP14AN9-Y-BLK-3H	#FP14AN18-Y-BLK-3H

## PRINTED NUMBERED FLAGS 400 DENIER

Sold In Sets Of 9 Only.

Color	Tube Lock 1-9	Tube Lock 10-18	Soft Pocket 1-9	Soft Pocket 10-18	Grommet 1-9	Grommet 10-18
White / Black Numbers	#FP14SPN9-W-BLK	#FP14SPN18-W-BLK	#FP14SPN9-W-BLK-SP	#FP14SPN18-W-BLK-SP	#FP14SPN9-W-BLK-3H	#FP14SPN18-W-BLK-3H
Blue / White Numbers	#FP14SPN9-B-W	#FP14SPN18-B-W	#FP14SPN9-B-W-SP	#FP14SPN18-B-W-SP	#FP14SPN9-B-W-3H	#FP14SPN18-B-W-3H
Red / White Numbers	#FP14SPN9-R-W	#FP14SPN18-R-W	#FP14SPN9-R-W-SP	#FP14SPN18-R-W-SP	#FP14SPN9-R-W-3H	#FP14SPN18-R-W-3H



Reorder easily @ [www.wittekgolf.com](http://www.wittekgolf.com)



# 100% CUSTOM FLAGS



These custom pattern flags are sold plain, screen printed or embroidered and in a variety of sizes! Give us a call and let us make a quote for you.



**BRISTOL**  
#FFP18-B  
#FFP14-B  
#FFP7-B  
#FFP6-B



**DIAGONAL BRISTOL**  
#FFP18-DB  
#FFP14-DB  
#FFP7-DB  
#FFP6-DB



**WINDSOR**  
#FFP18-W  
#FFP14-W  
#FFP7-W  
#FFP6-W



**DIAGONAL WINDSOR**  
#FFP18-DW  
#FFP14-DW  
#FFP7-DW  
#FFP6-DW



**PENNANT**  
#FFP18 - P  
#FFP14 - P  
#FFP7 - P  
#FFP6 - P



**SOLID PENNANT**  
#FFP18-SP  
#FFP14-SP  
#FFP7-SP  
#FFP6-SP

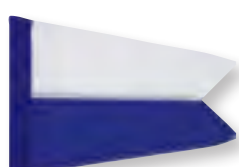

**BURGEE**  
#FFP18-BG  
#FFP14-BG  
#FFP7-BG  
#FFP6-BG



**SOLID BURGEE**  
#FFP18-SBG  
#FFP14-SBG  
#FFP7-SBG  
#FFP6-SBG



**SHEFFIELD**  
#FFP18-SH  
#FFP14-SH  
#FFP7-SH  
#FFP6-SH



**NEW CASTLE**  
#FFP18-NC  
#FFP14-NC  
#FFP7-NC  
#FFP6-NC



**DEVON**  
#FFP18-DV  
#FFP14-DV  
#FFP7-DV  
#FFP6-DV



**LEEDS**  
#FFP18-L  
#FFP14-L  
#FFP7-L  
#FFP6-L



**DUNDEE**  
#FFP18-DD  
#FFP14-DD  
#FFP7-DD  
#FFP6-DD



**ABERDEEN**  
#FFP18-A  
#FFP14-A  
#FFP7-A  
#FFP6-A

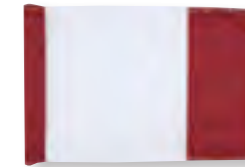

**EDINBURGH**  
#FFP18-E  
#FFP14-E  
#FFP7-E  
#FFP6-E



**YORK**  
#FFP18-Y  
#FFP14-Y  
#FFP7-Y  
#FFP6-Y



**SOUTH HAMPTON**  
#FFP18-SH  
#FFP14-SH  
#FFP7-SH  
#FFP6-SH



**ASCOT**  
#FFP18-AT  
#FFP14-AT  
#FFP7-AT  
#FFP6-AT



**AVON**  
#FFP18-AV  
#FFP14-AV  
#FFP7-AV  
#FFP6-AV



**LASER AVON**  
#FFP18-LAV  
#FFP14-LAV  
#FFP7-LAV  
#FFP6-LAV



# DYE SUBLIMATION

If your custom flag has 4 or more colors in it we recommend Dye Sublimation!

#FPDSUB- Dye Sub Flag

The perfect tournament flag has never been easier to order! Great for when you need a lot of decoration in only a small amount of space, or for when each hole's flag has a different design. While these flags do not carry the same warranty as our other flags do, we have several customers that have flown them for just as long as a standard flag without any issues.

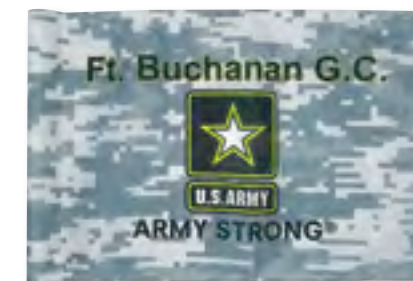



### MILITARY & CIVILIAN SERVICE FLAGS

Our military branch series flags include three, regulation size flags of each of the six United States Military branches (18 flags per set) and is a great way to honor our armed forces for those special holiday and patriotic tournaments and events!



Made with the same high quality material as our American golf course flags, you can proudly show your support with our "Back the Blue & Red" series flags. Offered in both regulation and putting green sizes.

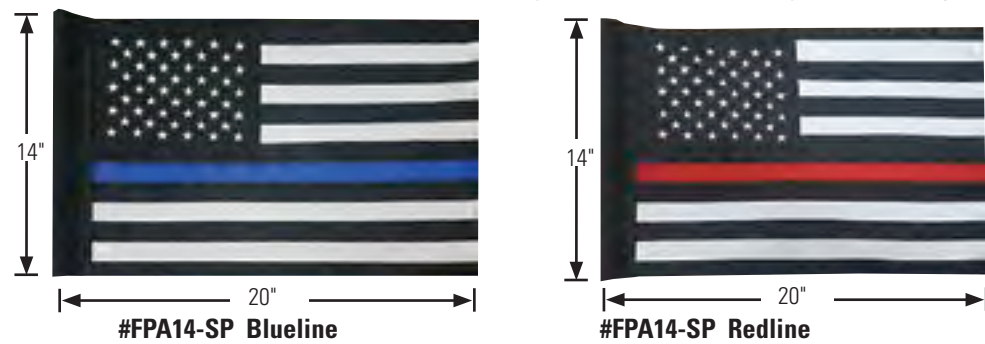

### INTERNATIONAL SERIES

Let us help you make a flag for any and every country for your course! Using a mix of embroidery, applique, screen print and dye sub, most country's flags are offered in regulation size as well as putting green size.



### HAND SEWN EMBROIDERED AMERICAN FLAGS



Our American flags are hand cut, hand sewn and embroidered right here in the U.S.A. by the most skilled seamstresses in the industry!

- #FPA3X5B - 3' x 5' Embroidered American Flag
#FPA4X6B - 4' x 6' Embroidered American Flag

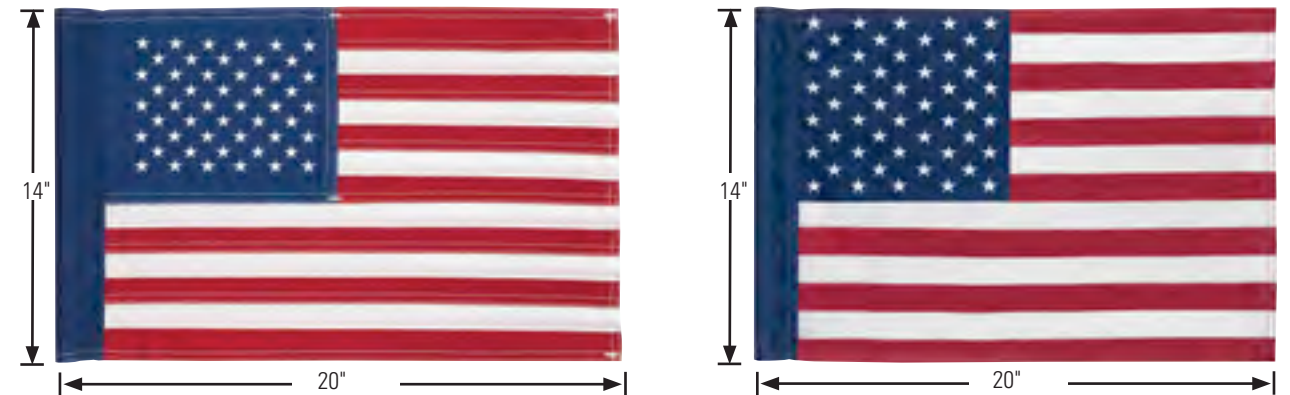

Our Embroidered American flags are pieced together and individually sewn in Vidalia, GA....America! The embroidered star field and 13 stripes are visible on front and back.

#FPA14-EMB - Embroidered

Our screen printed American flags are constructed using our white, 400 Denier nylon with a navy MFS and are printed on one side.

#FPA14-SP - Screen Printed



#FPA6-EMB - Embroidered

#FPA6-SP - Screen Printed

All four of our American flag options are stock items and available for quick ship.

See your invoices/statements @ www.wittekgolf.com



# WITTEK FLAGSTICKS



## 1/2" FLAGSTICKS

#400415	7½' White
#400416	7½' White with 2 Black Stripes
#400417	7½' White with 2 Blue Stripes
#400418	7½' White with 2 Green Stripes
#400419	7½' White with 2 Red Stripes
#400420	7½' White with 30" Black Bottom
#400421	7½' Yellow
#400422	7½' Yellow with 2 Black Stripes
#400423	7½' Yellow with 30" Black Bottom
#400411	5' White
#400436	5' Yellow
#400397	7½' White with Red & Blue Stripes
#400416B	7½' British Black Stripes

### ▶ THE WITTEK FERRULE

Zinc composition for extreme durability, 5 grooves for maximum sand drainage. Re-designed both taller and heavier, and it's made in the U.S.A!

#400407 - Zinc Ferrule



### ▶ OTHER FERRULES AND TOPS

- A. #400406 - Black Acorn Nut
- B. #400408 - Aluminum Flag Pole Top
- C. #26512ST - Smartfit Ferrule
- D. #26517ST - Traditional Ferrule



## 3/4" TAPERED TOURNAMENT FLAGSTICKS

#400424	7½' White
#400425	7½' White with 2 Black Stripes
#400426	7½' White with 2 Blue Stripes
#400427	7½' White with 2 Green Stripes
#400428	7½' White with 2 Red Stripes
#400429	7½' White with 30" Black Bottom
#400430	7½' Yellow
#400431	7½' Yellow with 2 Black Stripes
#400435	7½' Yellow with 30" Black Bottom

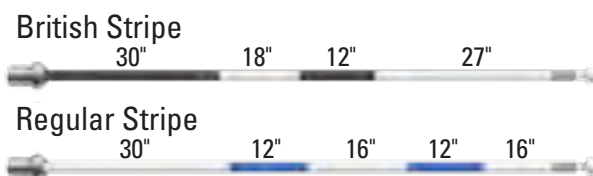

# WITTEK FLAGSTICKS W/ VINYL GUARD

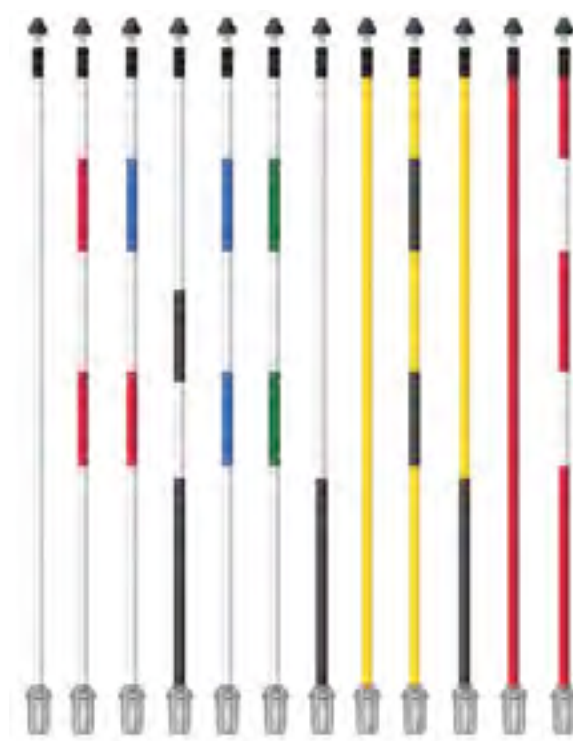

## 1/2" FLAGSTICKS

#400415-V	7½' White
#400416-V	7½' White with 2 Black Stripes
#400417-V	7½' White with 2 Blue Stripes
#400418-V	7½' White with 2 Green Stripes
#400419-V	7½' White with 2 Red Stripes
#400420-V	7½' White with 30" Black Bottom
#400421-V	7½' Yellow
#400422-V	7½' Yellow with 2 Black Stripes
#400423-V	7½' Yellow with 30" Black Bottom
400411-V	5' White
400436-V	5' Yellow
#400397-V	7½' White with Red & Blue Stripes
#400416-BV	7½' British Black Stripes

## 3/4" TAPERED TOURNAMENT FLAGSTICKS

#400424-V	7½' White
#400425-V	7½' White with 2 Black Stripes
#400426-V	7½' White with 2 Blue Stripes
#400427-V	7½' White with 2 Green Stripes
#400428-V	7½' White with 2 Red Stripes
#400429-V	7½' White with 30" Black Bottom
#400430-V	7½' Yellow
#400431-V	7½' Yellow with 2 Black Stripes
#400435-V	7½' Yellow with 30" Black Bottom



### ▶ PRISM LASER REFLECTOR

Easily replaces acorn nut on all flagsticks with 3/8" threaded tip. New five-glass prism pod design maximizes reflectivity, leaving no dead spots.

#402290



### ▶ LASER REFLECTOR

360° visibility, no dead spots, made with a highly reflective material with a large surface area. Fits both ½" regular poles and ¾" Tournament Poles. Sold in sets of 9

#400437



### ▶ ORIGINAL SPRYTE FLAG REFLECTOR

The original Spryte, works great with all Laser Range Finders at a fraction of the cost of other reflective tops. The soft foam base will not break or damage greens when flag sticks are dropped. 2" W x 2" D

#400438



### ▶ SPRYTE ELITE FLAG REFLECTOR

The Spryte Elite. The Spryte Elite will help range finder players locate their targets quickly and easily. And best of all, they won't break your budget. 1.75" W x 1.25" D

#400439



## FLAGSTICKS

### TOURNAMENT FLAGSTICKS

Take advantage of the remarkable strength, visibility and wind resistance of the Tournament Flagstick. Extra left in the center for added performance on greens. ½" diameter at both tip and ferrule; ¾" diameter at the center. 7½' - 2.5 lbs.



	#26300ST	7½' White
	#26301ST	7½' White with Black British Stripe
	#26302ST	7½' White with Red British Stripe
	#26303ST	7½' White with Green British Stripe
	#26304ST	7½' White with 30" Black Bottom
	#26310ST	7½' Yellow
	#26311ST	7½' Yellow with Black British Stripe
	#26314ST	7½' Yellow with 30" Black Bottom



### ROYALINE™ FLAGSTICKS

Ultra-strong, resilient, solid fiberglass construction. ½" diameter from top to bottom. Perfectly fit the ST2000 cups. 5' - 1 lbs.  
7½' - 1.5 lbs.

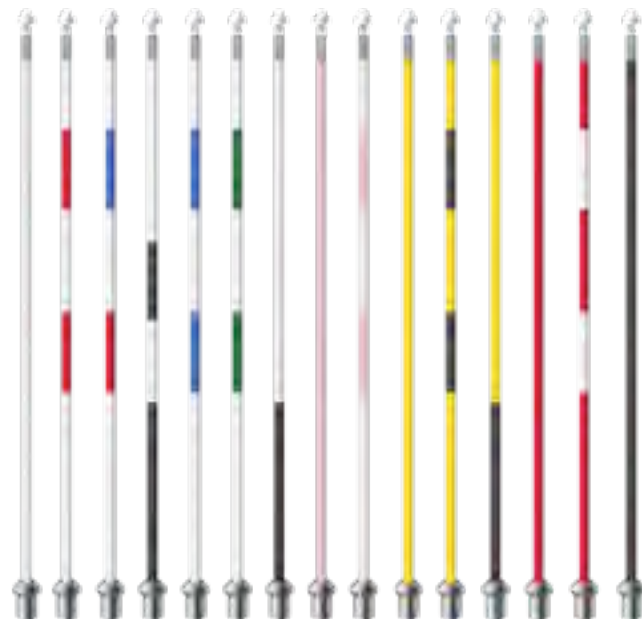

	#26995ST	5' White
	#26915ST	5' White with Red Stripe
	#26100ST	7½' White
	#26101ST	7½' White with Red Stripe
	#26102ST	7½' White with Blue & Red Stripe
	#26103ST	7½' White with Black British Stripe
	#26104ST	7½' White with Blue Stripe
	#26105ST	7½' White with Green Stripe
	#26106ST	7½' White with 30" Black Bottom
	#26107ST	7½' White with Pink Stripe
	#26110ST	7½' Yellow
	#26111ST	7½' Yellow with Black Stripe
	#26112ST	7½' Yellow with 30" Black Bottom
	#26120ST	7½' Red
	#26121ST	7½' Red with White Stripe
	#26130ST	7½' Black

## 6" REGULATION GREENS CUPS

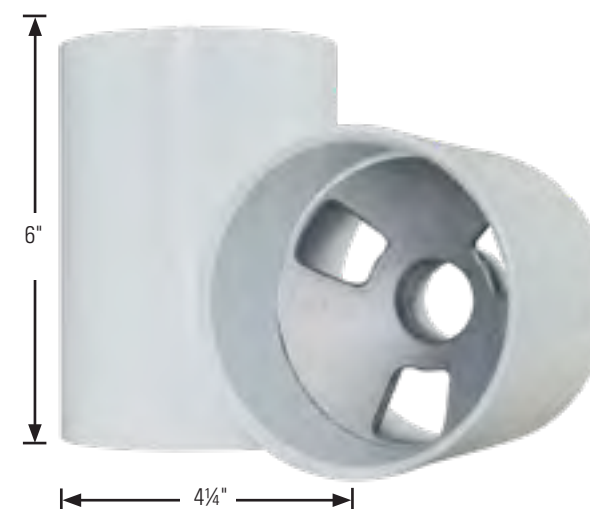

### 6" GREENS CUP

Available in either molded chemical resistant plastic or anodized powder coated aluminum. Meets all USGA requirements.

- #400100 - Aluminum (1½ lbs.)
- #400104 - Plastic (½ lbs.)

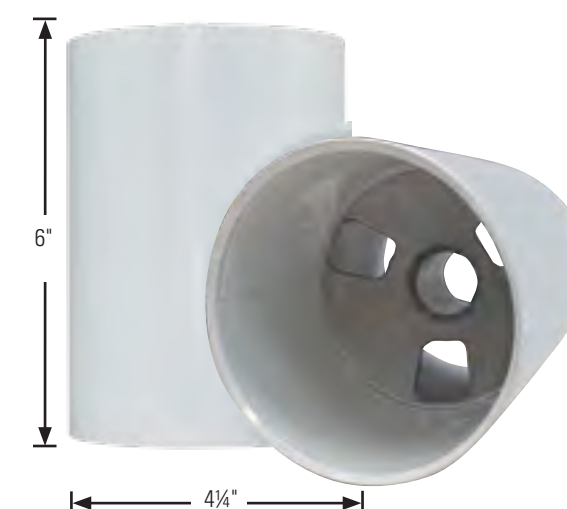

### ALUMINUM CUP WITH PLASTIC LINER

Featuring anodized powder coated aluminum, this cup meets all USGA requirement. Easily refresh the look of your courses cups by replacing the bright white liner!

#400119

### REPLACEMENT LINER

For aluminum 6" liner cup.

#400112-L

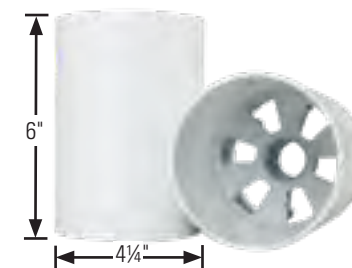

### ALUMINUM GREENS CUP

Unbeatable Chip-resistant finish. Six "feet" on bottom of cup eliminates sinking. Meets all USGA/R&A regulations. (1½ lbs.)

#18303ST

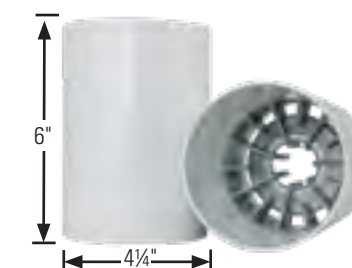

### ST2000 CUP

Notched ferrule flag sticks easily fit into place every time. Available in either chemical resistant plastic or chip resistant Bondrite™ aluminum. Meets all USGA requirements.

- #18333ST - Aluminum (1½ lbs.)
- #18222ST - Plastic (1½ lbs.)
- #18444ST - Hybrid (1 lbs.)

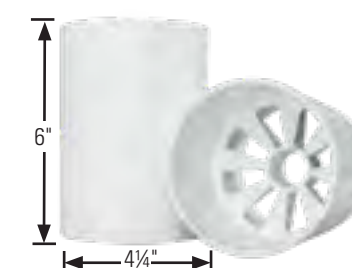

### PROLINE PLASTIC CUP

Ideal for less demanding conditions Brilliant White; finished with chemical-resistant polymers. Meets all USGA regulations.

#400867 (1½ lbs.)

See Page 77 For Putting Green 4" Cups

### WITTEK ONE TOUCH

**A huge improvement in ball retrieval made right here in the U.S.A!**

Featuring a one-piece design, the Wittek OneTouch is the easiest ball retriever to both apply and use.

The Wittek OneTouch snaps on to your regular or tapered flagsticks in less than one second. The 1.5" hook on top can then be pulled up with any club in the bag, sliding back down into the cup on its own after retrieval.

Made from industrial strength nylon in the U.S.A, the Wittek OneTouch is the ball retrieval solution you've been waiting for.

Easy to apply & easy to use!



#Wittek1Touch

Qty. 1-8

Qty. 9-17

Qty.



## PUTTING GREEN ACCESSORIES

### ▶ HOLE IN WHITE HOLE WHITENER SYSTEM

USGA approved, Hole in White is the most popular and the easiest way to paint the top of a cup. Simply press down and spin.

#400105 - Hole In White Tool

#400107 - Hole In White Paint

12 cans per case: Weight 13 lbs. 11" L x 8.5" W x 8.5" D



### ▶ SPEEDMETER

Made from extruded aluminum alloy with milled base to reduce bounce as the rolling ball makes contact with the green surface. Supplied complete with detailed instructions for an accurate measurement.

36" L x 2" W Weight 2 lbs.

#402205

### ▶ GREENS CUP ADVERTISING

An effective way to get your sponsors' name in front of customers. We can supply the transfers for you to apply, or we can supply the complete cups with graphics.

#S530

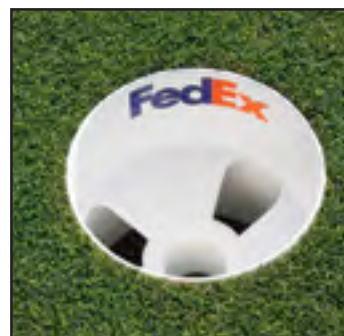

### ▶ HOLE TARGET RINGS

Bright white plastic Hole Target Rings sit just above the cup for added hole visibility. Easy insertion with most cup setters.

4" Diameter

#400861

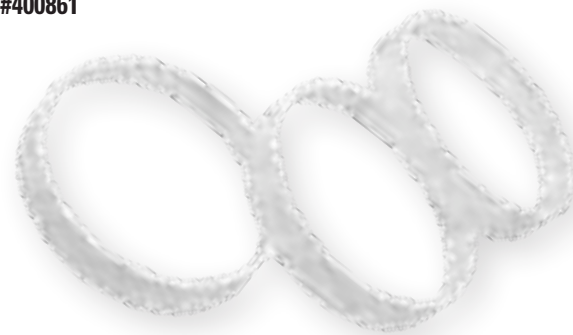

### ▶ PUTTING GREEN MARKERS

Classic putting green marker fits perfectly into any regulation golf cup. Fiberglass rod with a plastic base on the bottom. Weight .50 lbs.

#400450 White

#400451 White with Black Stripes

#400452 White with Blue Stripes

#400453 White with Green Stripes

#400454 White with Red Stripes

#400455 Yellow

#400456 Yellow with Black Stripes

#400457 Black



### ▶ PLASTIC BASE #400409

### ▶ SPIKED PUTTING GREEN MARKER

Made from laminated plastic with a 4 1/2" spike for easy movement on days when there aren't enough cups on your practice green!

## PRACTICE GREEN MARKERS



## 4" PRACTICE GREEN CUPS



### ▶ PLASTIC PUTTING GREEN CUP #400108 (.3 lbs.)

Molded from durable chemical-resistant polymers.



### ▶ PLASTIC PRACTICE GREEN CUP #400865 (.3 lbs.)

Features molded plastic construction and reinforced webs.



### ▶ ALUMINUM PRACTICE GREEN CUP #400103 (1 lb.)

Aluminum cup is anodized then powder coated a bright white. High wear area is dark gray to keep cups looking good and reduces maintenance.



### ▶ ALUMINUM PRACTICE GREEN CUP #18150ST (1 lb.)

Bonderite™ Aluminum for the most chip-resistant coating. Beveled bottom edge makes cups easier to insert and remove.

Chat with specialists @ [www.wittekgolf.com](http://www.wittekgolf.com)



# 6" X 8" EMBROIDERED PUTTING GREEN FLAGS 400 DENIER



Plastic Tube



Soft Tube



Standard Hem



Border Tape

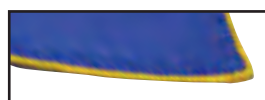

Merrow Border

## EMBROIDERED SOLID FLAGS - 400 DENIER

Color	Tubed	Soft Pocket
Red	#FPE6-R	#FPE6-R-SP
Blue	#FPE6-B	#FPE6-B-SP
Orange	#FPE6-O	#FPE6-O-SP
White	#FPE6-W	#FPE6-W-SP
Green	#FPE6-G	#FPE6-G-SP
Gold	#FPE6-GLD	#FPE6-GLD-SP
Yellow	#FPE6-Y	#FPE6-Y-SP
Black	#FPE6-BLK	#FPE6-BLK-SP
Navy Blue	#FPE6-NB	#FPE6-NB-SP
Purple	#FPE6-P	#FPE6-P-SP
Pink	#FPE6-PNK	#FPE6-PNK-SP



## EMBROIDERED HANDLE AND BORDER - 400 DENIER

Color	Tubed	Soft Pocket
Red/Black Border	#FPE6-R-BLK	#FPE6-R-BLK-SP
White/Black Border	#FPE6-W-BLK	#FPE6-W-BLK-SP
White/Green Border	#FPE6-W-G	#FPE6-W-G-SP
Yellow/Black Border	#FPE6-Y-BLK	#FPE6-Y-BLK-SP
Yellow/Green Border	#FPE6-Y-G	#FPE6-Y-G-SP
Blue/Black Border	FPE6-B-BLK	#FPE6-B-BLK-SP



## EMBROIDERED MERROW BORDER - 400 DENIER

Color	Tubed	Soft Pocket
Red/Black Border	#FPE6M-R-BLK	#FPE6M-R-BLK-SP
White/Black Border	#FPE6M-W-BLK	#FPE6M-W-BLK-SP
White/Green Border	#FPE6M-W-G	#FPE6M-W-G-SP
Yellow/Black Border	#FPE6M-Y-BLK	#FPE6M-Y-BLK-SP
Yellow/Green Border	#FPE6M-Y-G	#FPE6M-Y-G-SP
Blue/Black Border	#FPE6M-B-BLK	#FPE6M-B-BLK-SP

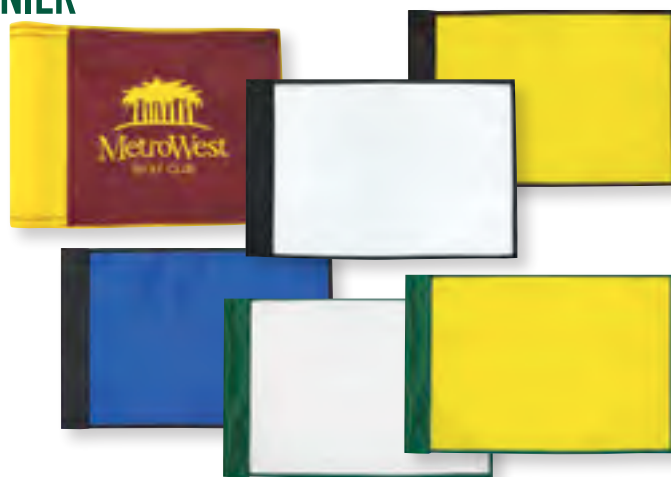

## EMBROIDERED LASER CUT CHECKERED - 400 DENIER

Color	Tubed	Soft Pocket
Black-White Checks	#FLCE6-BLK-W	#FLCE6-BLK-W-SP
Black-Yellow Checks	#FLCE6-BLK-Y	#FLCE6-BLK-Y-SP
Blue-White Checks	#FLCE6-B-W	#FLCE6-B-W-SP
Red-White Checks	#FLCE6-R-W	#FLCE6-R-W-SP
Green-White Checks	#FLCE6-G-W	#FLCE6-G-W-SP



## EMBROIDERED SEWN CHECKERED - 400 DENIER

Color	Tubed	Soft Pocket
Black-White Checks	#FCE6-BLK-W	#FCE6-BLK-W-SP
Black-Yellow Checks	#FCE6-BLK-Y	#FCE6-BLK-Y-SP
Blue-White Checks	#FCE6-B-W	#FCE6-B-W-SP
Red-White Checks	#FCE6-R-W	#FCE6-R-W-SP
Green-White Checks	#FCE6-G-W	#FCE6-G-W-SP





# 6" X 8" SCREEN PRINTED PUTTING GREEN FLAGS 400 DENIER



Plastic Tube



Soft Tube



Standard Hem



Border Tape

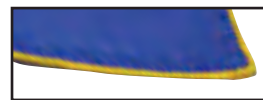

Merrow Border

## ▶ SCREEN PRINTED SOLID FLAGS – 400 DENIER

Color	Tubed	Soft Pocket
Red	#FPS6-R	#FPS6-R-SP
Blue	#FPS6-B	#FPS6-B-SP
Orange	#FPS6-O	#FPS6-O-SP
White	#FPS6-W	#FPS6-W-SP
Green	#FPS6-G	#FPS6-G-SP
Gold	#FPS6-GLD	#FPS6-GLD-SP
Yellow	#FPS6-Y	#FPS6-Y-SP
Black	#FPS6-BLK	#FPS6-BLK-SP
Navy Blue	#FPS6-NB	#FPS6-NB-SP
Purple	#FPS6-P	#FPS6-P-SP
Pink	#FPS6-PNK	#FPS6-PNK-SP



## ▶ SCREEN PRINTED HANDLE AND BORDER – 400 DENIER

Color	Tubed	Soft Pocket
Red/Black Border	#FPS6-R-BLK	#FPS6-R-BLK-SP
White/Black Border	#FPS6-W-BLK	#FPS6-W-BLK-SP
White/Green Border	#FPS6-W-G	#FPS6-W-G-SP
Yellow/Black Border	#FPS6-Y-BLK	#FPS6-Y-BLK-SP
Yellow/Green Border	#FPS6-Y-G	#FPS6-Y-G-SP
Blue/Black Border	#FPS6-B-BLK	#FPS6-B-BLK-SP



## ▶ SCREEN PRINTED MERROW BORDER – 400 DENIER

Color	Tubed	Soft Pocket
Red/Black Border	#FPS6M-R-BLK	#FPS6M-R-BLK-SP
White/Black Border	#FPS6M-W-BLK	#FPS6M-W-BLK-SP
White/Green Border	#FPS6M-W-G	#FPS6M-W-G-SP
Yellow/Black Border	#FPS6M-Y-BLK	#FPS6M-Y-BLK-SP
Yellow/Green Border	#FPS6M-Y-G	#FPS6M-Y-G-SP
Blue/Black Border	#FPS6M-B-BLK	#FPS6M-B-BLK-SP

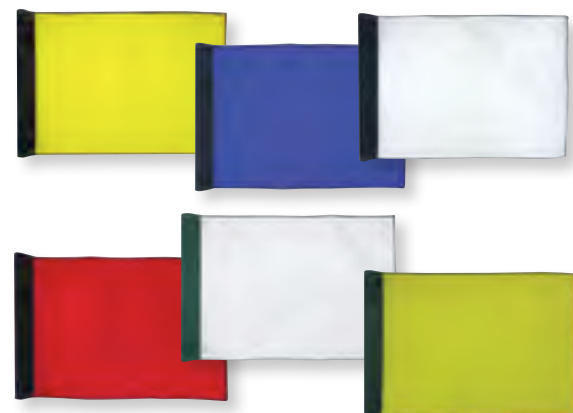

## ▶ SCREEN PRINTED LASER CUT CHECKERED – 400 DENIER

Color	Tubed	Soft Pocket
Black-White Checks	#FLCS6-BLK-W	#FLCS6-BLK-W-SP
Black-Yellow Checks	#FLCS6-BLK-Y	#FLCS6-BLK-Y-SP
Blue-White Checks	#FLCS6-B-W	#FLCS6-B-W-SP
Red-White Checks	#FLCS6-R-W	#FLCS6-R-W-SP
Green-White Checks	#FLCS6-G-W	#FLCS6-G-W-SP

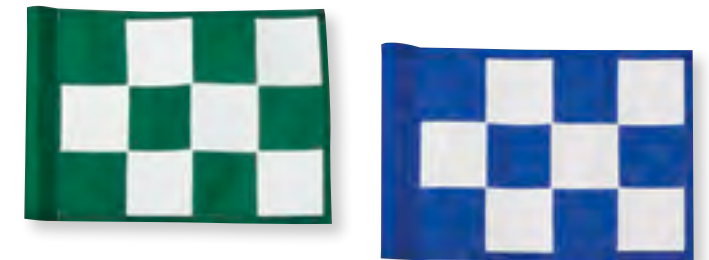

## ▶ SCREEN PRINTED SEWN CHECKERED – 400 DENIER

Color	Tubed	Soft Pocket
Black-White Checks	#FSE6-BLK-W	#FSE6-BLK-W-SP
Black-Yellow Checks	#FSE6-BLK-Y	#FSE6-BLK-Y-SP
Blue-White Checks	#FSE6-B-W	#FSE6-B-W-SP
Red-White Checks	#FSE6-R-W	#FSE6-R-W-SP
Green-White Checks	#FSE6-G-W	#FSE6-G-W-SP





# 6" X 8" PLAIN PUTTING GREEN FLAGS 400 DENIER



Plastic Tube



Soft Tube



Standard Hem



Border Tape

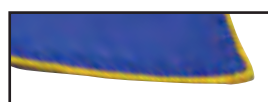

Merrow Border

## PLAIN FLAGS - 400 DENIER

Color	Tubed	Soft Pocket
Red	#FP6-R	#FP6-R-SP
Blue	#FP6-B	#FP6-B-SP
Orange	#FP6-O	#FP6-O-SP
White	#FP6-W	#FP6-W-SP
Green	#FP6-G	#FP6-G-SP
Gold	#FP6-GLD	#FP6-GLD-SP
Yellow	#FP6-Y	#FP6-Y-SP
Black	#FP6-BLK	#FP6-BLK-SP
Navy Blue	#FP6-NB	#FP6-NB-SP
Purple	#FP6-P	#FP6-P-SP
Pink	#FP6-PNK	#FP6-PNK-SP



## PLAIN HANDLE AND BORDER - 400 DENIER

Color	Tubed	Soft Pocket
Red/Black Border	#FP6-R-BLK	#FP6-R-BLK-SP
White/Black Border	#FP6-W-BLK	#FP6-W-BLK-SP
White/Green Border	#FP6-W-G	#FP6-W-G-SP
Yellow/Black Border	#FP6-Y-BLK	#FP6-Y-BLK-SP
Yellow/Green Border	#FP6-Y-G	#FP6-Y-G-SP
Blue/Black Border	#FP6-B-BLK	#FP6-B-BLK-SP



## PLAIN MERROW BORDER FLAGS - 400 DENIER

Color	Tubed	Soft Pocket
Red/Black Border	#FP6M-R-BLK	#FP6M-R-BLK-SP
White/Black Border	#FP6M-W-BLK	#FP6M-W-BLK-SP
White/Green Border	#FP6M-W-G	#FP6M-W-G-SP
Yellow/Black Border	#FP6M-Y-BLK	#FP6M-Y-BLK-SP
Yellow/Green Border	#FP6M-Y-G	#FP6M-Y-G-SP
Blue/Black Border	#FP6M-B-BLK	#FP6M-B-BLK-SP



## LASER CUT CHECKERED FLAGS - 400 DENIER

Color	Tubed	Soft Pocket
Black-White Checks	#FPLC6-BLK-W	#FPLC6-BLK-W-SP
Black-Yellow Checks	#FPLC6-BLK-Y	#FPLC6-BLK-Y-SP
Blue-White Checks	#FPLC6-B-W	#FPLC6-B-W-SP
Red-White Checks	#FPLC6-R-W	#FPLC6-R-W-SP
Green-White Checks	#FPLC6-G-W	#FPLC6-G-W-SP



## PLAIN SEWN CHECKERED FLAGS - 400 DENIER

Color	Tubed	Soft Pocket
Black-White Checks	#FPC6-BLK-W	#FPC6-BLK-W-SP
Black-Yellow Checks	#FPC6-BLK-Y	#FPC6-BLK-Y-SP
Blue-White Checks	#FPC6-B-W	#FPC6-B-W-SP
Red-White Checks	#FPC6-R-W	#FPC6-R-W-SP
Green-White Checks	#FPC6-G-W	#FPC6-G-W-SP

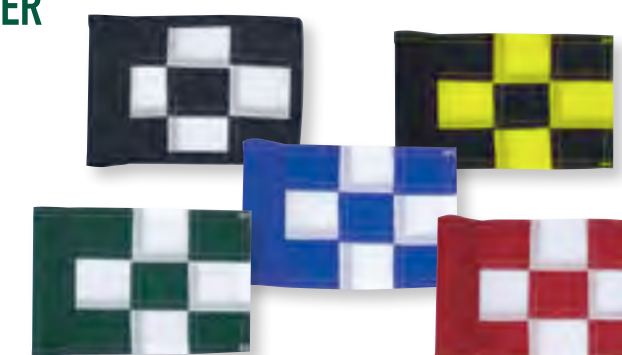

## APPLIQUE NUMBERED FLAGS 400 DENIER

Sold In Sets Of 9 Only.

Color	Tube Lock 1-9	Tube Lock 10-18	Soft Pocket 1-9	Soft Pocket 10-18
White / Black Numbers	#FP6AN9-W-BLK	#FP6AN18-W-BLK	#FP6AN9-W-BLK-SP	#FP6AN18-W-BLK-SP
Blue / White Numbers	#FP6AN9-B-W	#FP6AN18-B-W	#FP6AN9-B-W-SP	#FP6AN18-B-W-SP
Red / White Numbers	#FP6AN9-R-W	#FP6AN18-R-W	#FP6AN9-R-W-SP	#FP6AN18-R-W-SP
Yellow / Black Numbers	#FP6AN9-Y-BLK	#FP6AN18-Y-BLK	#FP6AN9-Y-BLK-SP	#FP6AN18-Y-BLK-SP



## PRINTED NUMBERED FLAGS 400 DENIER

Sold In Sets Of 9 Only.

Color	Tube Lock 1-9	Tube Lock 10-18	Soft Pocket 1-9	Soft Pocket 10-18
White / Black Numbers	#FP6SPN9-W-BLK	#FP6SPN18-W-BLK	#FP6SPN9-W-BLK-SP	#FP6SPN18-W-BLK-SP
Blue / White Numbers	#FP6SPN9-B-W	#FP6SPN18-B-W	#FP6SPN9-B-W-SP	#FP6SPN18-B-W-SP
Red / White Numbers	#FP6SPN9-R-W	#FP6SPN18-R-W	#FP6SPN9-R-W-SP	#FP6SPN18-R-W-SP
Yellow / Black Numbers	#FP6SPN9-Y-BLK	#FP6SPN18-Y-BLK	#FP6SPN9-Y-BLK-SP	#FP6SPN18-Y-BLK-SP



# PRACTICE GREEN FLAGSTICKS

## PRACTICE GREEN ROD

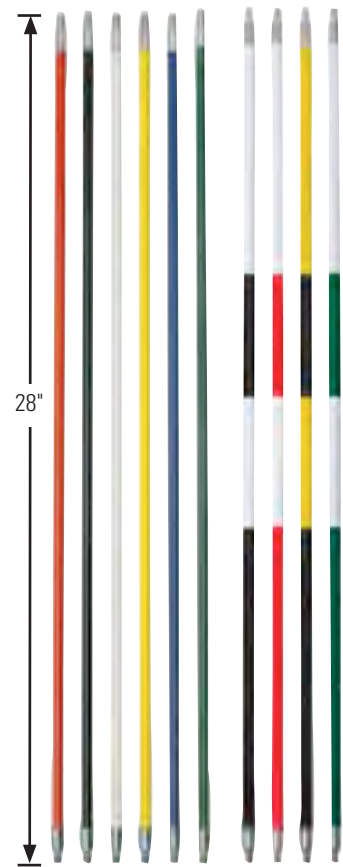

- Solid, resilient fiberglass construction
- 3/8" (1cm) diameter; 28" (71 cm) long
- Knob and base sold separately

## JR. TOURNAMENT PRACTICE GREEN ROD

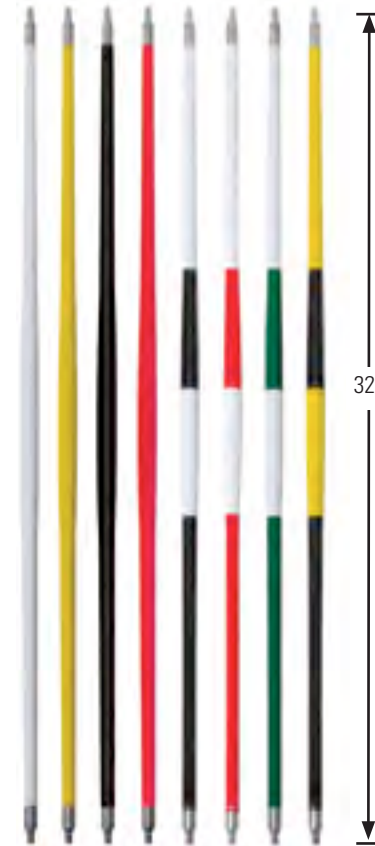

- 1/2" (1.3 cm) diameter tip and ferrule leads to a 3/4" (1.9 cm) center; 32" (81 cm) long
- Fits 1/2" (1.3 cm) practice green flags only
- Knob and base sold separately

**FITS LARGE TUBE PRACTICE GREEN FLAGS**

SOLID ROD ONLY		STRIPED ROD ONLY	
Red	#20182ST	Black/White	#20010ST
Black	#20282ST	White/Red	#20020ST
White	#20382ST	Yellow/Black	#20030ST
Yellow	#20482ST	Green/White	#20040ST
Blue	#20582ST		
Green	#20682ST		

SOLID ROD ONLY		STRIPED ROD ONLY	
White	#20200ST	Black/White	#20201ST
Yellow	#20225ST	Red/White	#20202ST
Black	#20227ST	Green/White	#20203ST
Red	#20228ST	Black/Yellow	#20204ST



**▶ KNOB FOR PRACTICE GREEN ROD**  
#402371 - Marker Knob (.2 lbs.)



**▶ SOLID METAL BASE**  
4 1/4" H x 2 1/4" W  
#402370



**▶ KNOB FOR JR. TOURNAMENT PRACTICE GREEN ROD**  
#402372 - Jr Tournament (.3 lbs.)

# PRACTICE GREEN MARKERS

## ▶ CAST ALUMINUM PRACTICE GREEN MARKERS

- The resiliency and functionality of cast aluminum.
- Plain or personalized with sets of numbered decals or your club logo.
- Fits 3/8" rods only.



- #20537ST - Black Aluminum Head Only
- #20536ST - Blue Aluminum Head Only
- #20535ST - Green Aluminum Head Only
- #20534ST - Red Aluminum Head Only
- #20532ST - White Aluminum Head Only
- #20533ST - Yellow Aluminum Head Only

## ▶ PRACTICE GREEN MARKER DECALS

Color	#1-9	#10-18
Black	#402380	#402381
Blue	#402382	#402383
Red	#402384	#402385
White	#402386	#402387
Yellow	#402388	#402389

\*Sold as a Set of 2\*  
 #20511ST - 36 Personalized Decals  
 #20512ST - 54 Personalized Decals  
 #20513ST - 72 Personalized Decals  
 #20514ST - 108 Personalized Decals  
 #20515ST - 144 Personalized Decals  
 #20516ST - 216 Personalized Decals  
 #402009 - Art Charge



## ▶ NUMBERED PRACTICE GREEN PENNANT SETS

- Classic, one-piece plastic head and fiberglass rod combinations.
- Order them in single units (one plastic head, rod and base) or as a set (nine units).

	Flag Only	Single Unit with rod and base	Set 1-9 with rod and base	Set 10-18 with rod and base
White Head/Red Rod	#20393ST	#20392ST	#20391ST	#20390ST
White Head/Green Rod	#20493ST	#20492ST	#20491ST	#20490ST
Black Head/Yellow Rod	#20593ST	#20592ST	#20591ST	#20590ST

\*Specify hole numbers when ordering single flags.



## ▶ CUSTOM PUTTING MARKER HEADS

Custom heads made from highly durable laminated plastic are alternatives to using putting flags.



Laminate putting green markers work with Wittek putting green markers. See page 79

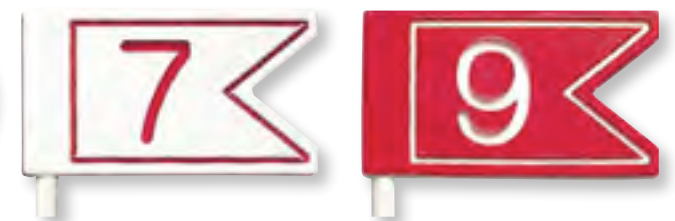



# LAMINATE DIRECTIONAL SIGNS



Easy to read, long-lasting laminate signs are available in 2 popular standard colors. All signs can be single-sided or double-sided. Complete with two 5" steel spikes. For custom wording, colors and languages, please call.



All of these signs can be mounted on a 2" x 2" stake with spike, Please give us a call.



No. of Sides	Size	Green/White	Yellow/Black
Single-Sided	12" W x 6" H (1.75 lbs.)	#405880	#405882
Double-Sided	12" W x 6" H (1.75 lbs.)	#405883	#405885
Single-Sided	15" W x 9" H (3.5 lbs.)	#405886	#405888
Double-Sided	15" W x 9" H (3.5 lbs.)	#405889	#405891

Example: Green/White Single Sided 12" x 6" - No Carts - 405880-05

The following colors are available in only 1/2" White/Green/White Brown/White/Brown

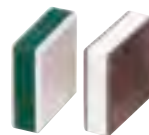

The following colors are available in both 1/2" and 3/4" Green/White/Green Blue/White/Blue Red/White/Red Black/White/Black Yellow/Black/Yellow

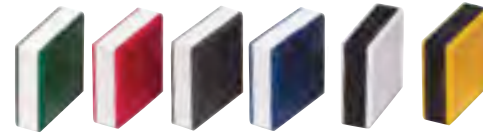

- #T0401 - Green/White/Green w/ Slider Tracks
- #T0402 - Yellow/Black/Yellow w/ Slider Tracks
- #T0403 - Blue/White/Blue w/ Slider Tracks
- #T0404 - Red/White/Red w/ Slider Tracks
- #T0405 - Custom color / messages



## TODAY'S YARDAGE SIGN

Perfect for your par 3's, especially on tournament and outing days! Speed up play by setting the yardage in the morning, eliminating players having to measure on the tee box. Made from laminated plastic, this double sided sign gives you the ability to insert a new yardage whenever needed. Please specify color/message when ordering custom.



# ALUMINUM DIRECTIONAL SIGNS



- 10" x 6" sign face, 1/8" thick.
- Durable, powder coated finish out-performs conventional paint.
- Easily customized with your message.
- Double-sided signs with arrows have the direction reversed on the 'back'.
- Other color combinations and languages available - call for details.

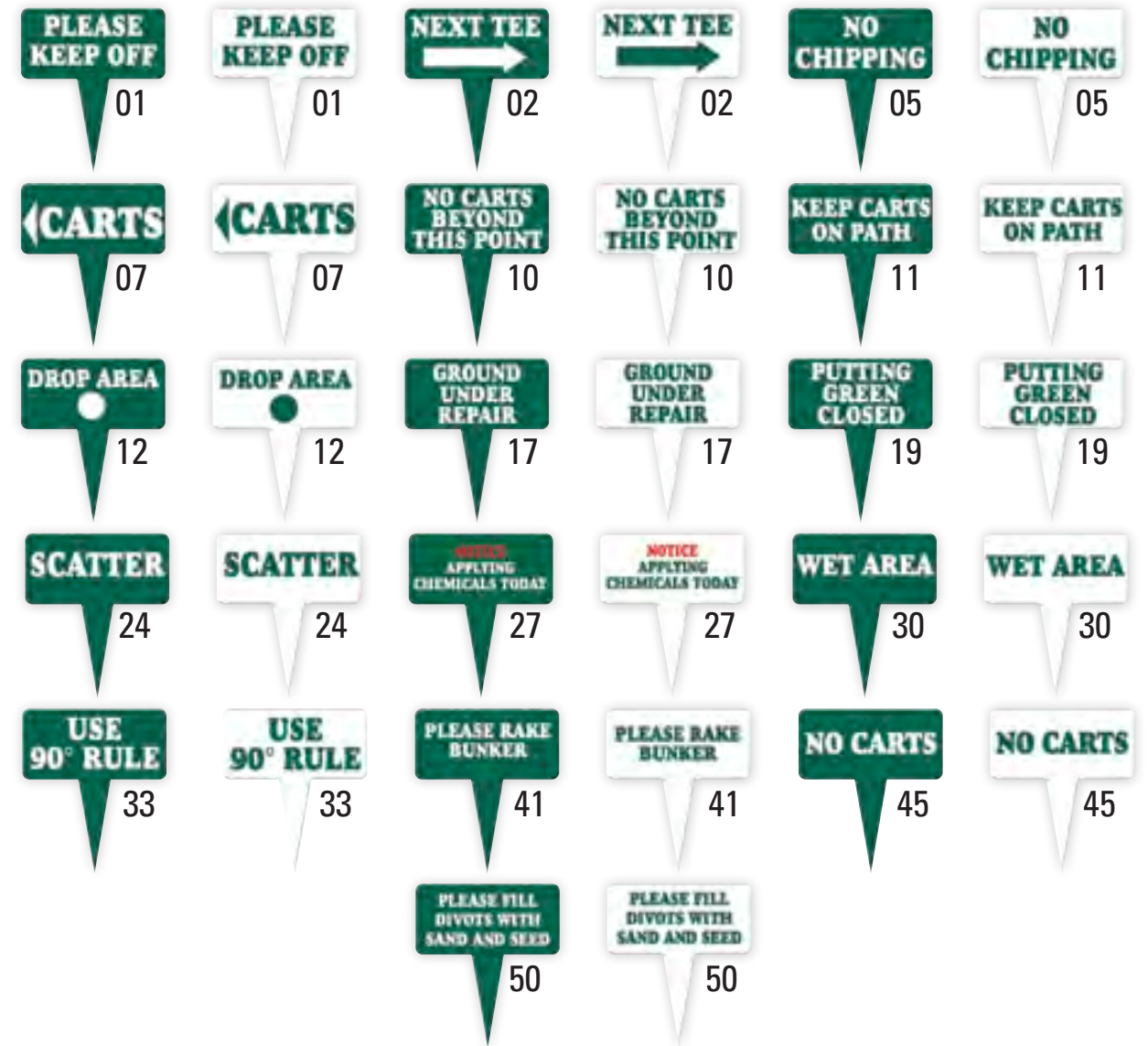

Color	Size	
Green Sign, White Letters	10" W x 6" H (.65 lbs.)	#405893
White Sign, Green Letters	10" W x 6" H (.65 lbs.)	#405892
Custom	10" W x 6" H (.65 lbs.)	#405893-51

Example: Green/White 10 x 6" - Next Tee - 405893-02



## CUSTOM TEE & INFORMATION SIGNS

- Stylish. Low maintenance. 3/4" laminate weather-resistant signs.
- Tee signs can include club logo, hole number, par, yardage with optional hole layout.
- Sign can be pre-drilled for easy installation.  
Please specify if you do want the signs drilled when ordering.
- Mounting Post sold separately.

Call 800-869-1800  
for a proof and a price!

# ORDERING IS AS EASY AS 1-2-3

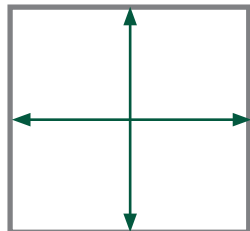
**#1** Size & Shape 

Popular Sizes  
12 x 18  
14 x 20  
18 x 24



**#2** Hole number, Par, Tee w/Distance, # Tees, Layout, Material, Lexan or Engraved



Sample With Layout  
#405004



Sample Without Layout  
#405005

**#3** Custom Logo & Mounting Post



### POSTS

The perfect mounting option for our Tee Signs, our 4" x 4" recycled plastic posts feature a decorative beveled top.

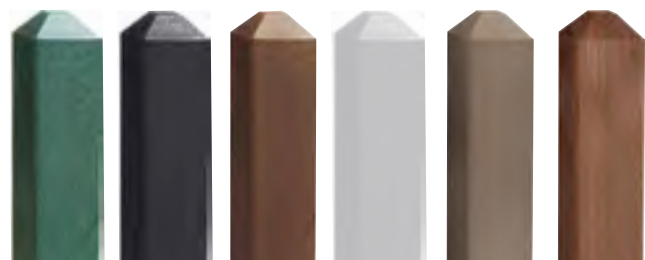

Length	Green	Black	Brown	White	Driftwood	Walnut
4 Ft	#405050-4	#405051-4	#405052-4	#405053-4	#405056-4	#405055-4
5 Ft	#405050-5	#405051-5	#405052-5	#405053-5	#405056-5	#405055-5
6 Ft	#405050-6	#405051-6	#405052-6	#405053-6	#405056-6	#405055-6
7 Ft	#405050-7	#405051-7	#405052-7	#405053-7	#405056-7	#405055-7
8 Ft	#405050-8	#405051-8	#405052-8	#405053-8	#405056-8	#405055-8

Give us a call for all of your custom signage needs!

## A-FRAME SIGNS

These dual color A-Frame signs are made of a durable, stain resistant, 1/2" laminated sign board. Messages can be engraved to highlight core color or color filled for your preferred font appearance.

Other features include a handsome engraved outline running along the outer edges of this sign allowing it to "pop" and a convenient handle near the top.



The following colors are available in only 1/2"  
White/Green/White  
Brown/White/Brown

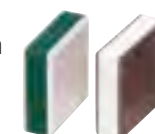

The following colors are available in both 1/2" and 3/4"  
Green/White/Green  
Blue/White/Blue  
Red/White/Red  
Black/White/Black  
Yellow/Black/Yellow

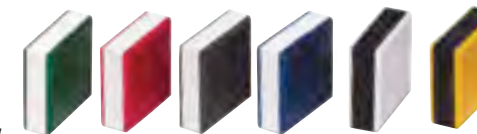

## CUSTOM SIGNS

Our sign department has many years of experience in the design and manufacturing of many different types of golf course and clubhouse signage.

All work is done in house with our focus on long lasting, low maintenance signs that will look great for years. No matter what type of message you need to convey - from large entryway signs to small directional signs, our design and manufacturing team can make it happen.



NEED IT QUICKLY? FAST TURN AROUNDS ARE OUR SPECIALTY!

Chat with specialists @ [www.wittekgolf.com](http://www.wittekgolf.com)



# CUSTOM TEE & INFORMATION SIGNS



SOLID BRONZE OR ALUMINUM



SHOWN IN: ALUMINUM WITH ROLLED GOLD  
HANGER ARM MOUNTED WITH SPONSOR SIGN



## SIGNATURE

SHOWN IN: POLISHED BRONZE



## CLASSIC

SHOWN IN: POLISHED ALUMINUM



## IMPERIAL

SHOWN IN: ALUMINUM WITH ROLLED GOLD

- #405016 - Custom Cast Aluminum Tee Sign
- #405017 - Custom Bronze Tee Sign
- #405018 - Custom Cast Aluminum Information Sign
- #405019 - Custom Bronze Information Sign

Special pricing available for 18 hole packages!

## STANDARD SHAPES



## POSTS & MOUNTING



SQUARE    SMOOTH    FLUTED



DIRECT MOUNT    SIDE MOUNT    HANGER MOUNT

## IN-GROUND



## SQUARE

SHOWN IN: POLISHED BRONZE



## CIRCLE

SHOWN IN: POLISHED ALUMINUM



## RECTANGLE

SHOWN IN: POLISHED BRONZE



## OVAL

SHOWN IN: ALUMINUM WITH ROLLED GOLD

## TEE MARKERS

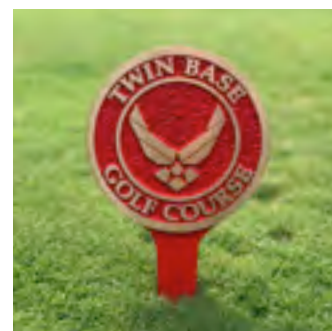

## LOLLYPOP

SHOWN IN: CRIMSON RED WITH POLISHED BRONZE

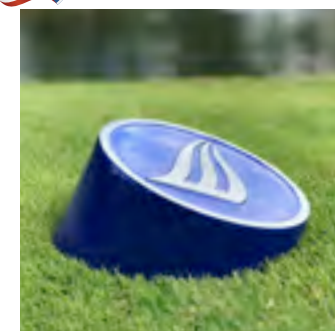

## WEDGE

SHOWN IN: CAPRI BLUE WITH POLISHED ALUMINUM



## COLOR RING

SHOWN IN: BLACK/CRIMSON RED WITH POLISHED ALUMINUM

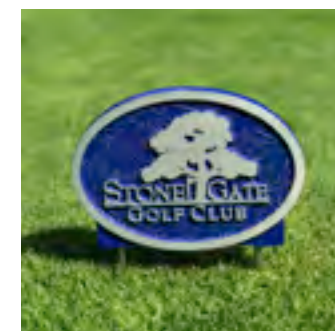

## ALUMINUM SPIKE

SHOWN IN: CAPRI BLUE WITH POLISHED ALUMINUM

## STANDARD SHAPES



## CART PATH PYRAMIDS



**BRONZE PYRAMID**  
SHOWN IN: 26077 DARK BRONZE WITH POLISHED BRONZE



**ALUMINUM PYRAMID**  
SHOWN IN: BLACK WITH POLISHED ALUMINUM



**ALUMINUM WITH COLOR**  
SHOWN IN: CAPRI BLUE WITH POLISHED ALUMINUM

## STANDARD COLORS

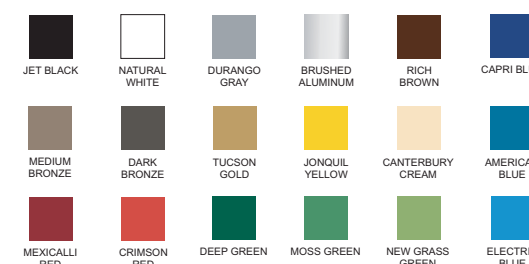

## LOGO OPTIONS AVAILABLE



**CUSTOM OPTIONS AVAILABLE**  
CALL FOR SPECIAL REQUESTS

ASK ABOUT OUR FULL LINE OF CAST METAL SIGNAGE & MARKERS

Reorder easily @ [www.wittekgolf.com](http://www.wittekgolf.com)



# ALUMINUM INFORMATIONAL SIGNS

- Single-sided.
- Order Sign Posts separately
- Weather- Resistant Ink
- Call to Discuss Custom Signage



All of these signs can be mounted on a 2" x 2" stake with spike, Please give us a call.



#406367 - 12" X 12"



#406363 - 12" X 12"



#406368 - 12" X 12"



#406369 - 12" X 12"



#406373 - 12" X 12"



#406370 - 12" X 12"



#406372 - 12" X 12"



#406371 - 12" X 12"



Rattlesnakes #407040 - 12" X 12"



Alligators/Rattlesnakes #407041 - 12" X 12"



#406377 - Wisconsin - 12" X 12"

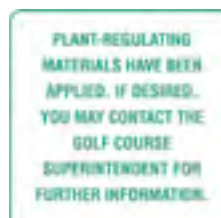

#406376 - Kentucky - 12" X 12"

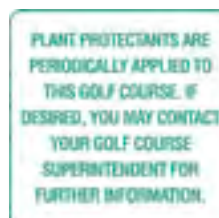

#406375 - Illinois - 12" X 12"



Recycled Products #407044 - 12" X 12"



Today's Turf Schedule #407051 - 24" X 18"



Cart Crossing #407011 - 18" #407012 - 24"



Don't Drink The Water #407049 - 12" X 18"



Caution Speed Bumps #407013 - 12" #407014 - 24"



#407001 - Stop 12" #407002 - Stop 18" #407003 - Stop 24"



Handicap Parking Only #407020 - 12" X 18"

# CUSTOM TEE MARKERS



## MOLDED TEE MARKERS

Are you looking for your logo to come to life on the tee box? Our expert design staff has years of experience and can create just what you are looking for. Made of super strong epoxy resins, molded tee markers can be easily colored or highlighted to indicate various tee locations. **Call today to discuss the many options available.**



## LAMINATED TEE MARKERS





# TEE MARKERS

## CUBE TEE MARKER

- Simple square cube makes an attractive angular marker design.
- 100% recycled material.
- 3½"H x 3½"W with 4" spike (1.11 lbs.).

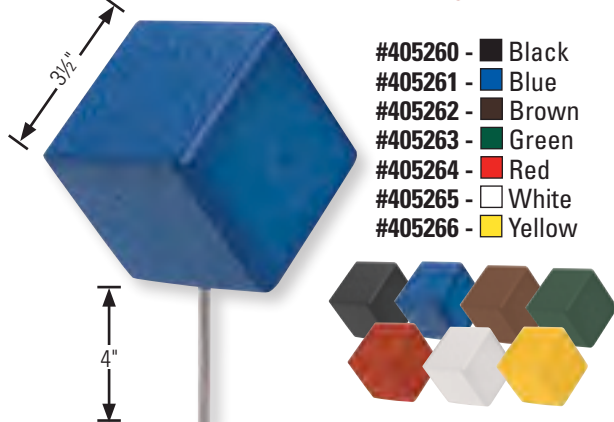

- #405260 - Black
- #405261 - Blue
- #405262 - Brown
- #405263 - Green
- #405264 - Red
- #405265 - White
- #405266 - Yellow

## Double-Stack Tee Marker

- Stacked, high-profile beveled tower design enhances any tee area.
- 100% recycled material.
- 6"H x 4"W with 4" spike (1.72 lbs.).

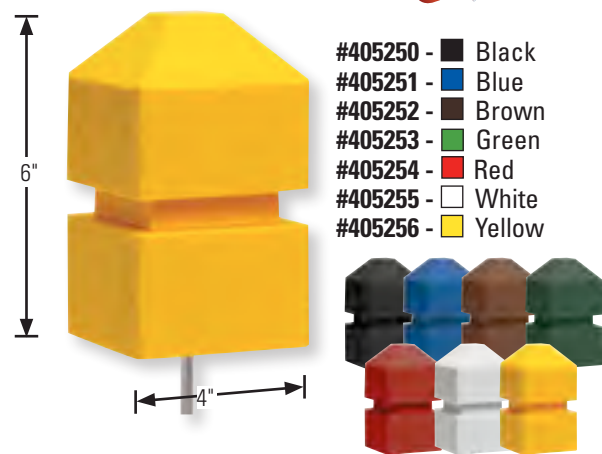

- #405250 - Black
- #405251 - Blue
- #405252 - Brown
- #405253 - Green
- #405254 - Red
- #405255 - White
- #405256 - Yellow

## BALL TEE MARKER

These durable tee markers are made to last and look great for many seasons. They are also easily refurbished to look like new. Made from a special formula resin, these tee markers look and feel similar to a billiard ball. Logo's can be added - call for details.

Color	3"	3" w/ Neck	4"	4" w/ Neck	5"	5" w/ Neck
Black	#400130	#400140	#400150	#400160	#400170	#400180
Blue	#400131	#400141	#400151	#400161	#400171	#400181
Gray	#400132	#400142	#400152	#400162	#400172	#400182
Green	#400133	#400143	#400153	#400163	#400173	#400183
Marigold	#400134	#400144	#400154	#400164	#400174	#400184
Red	#400135	#400145	#400155	#400165	#400175	#400185
White	#400136	#400146	#400156	#400166	#400176	#400186
Yellow	#400137	#400147	#400157	#400167	#400177	#400187



## CLASSIC-T MARKER

- One-piece, easy-to-handle design.
- Economical option, built to last.
- 3½" D with 3" spike (1 lbs.).



- #5600ST - Red
- #5601ST - White
- #5602ST - Blue
- #5603ST - Yellow
- #5605ST - Black
- #5608ST - Orange
- #5609ST - Green

## PLAIN DIMPLE-T MARKER

- The original. Most durable ever built.
- Favorite of golf courses worldwide.
- 5"D with 4½" spike (1 lbs.).



- #5250ST - Red
- #5251ST - White
- #5252ST - Blue
- #5253ST - Yellow
- #5255ST - Black
- #5256ST - Silver
- #5257ST - Gold
- #5258ST - Orange
- #5259ST - Green

## PERSONALIZED DIMPLE-T MARKER

- Personalize the classic Dimple-T Marker with your club logo.
- Decals priced separately.
- 5"D with 4½" spike (1 lbs.).



- #5270ST - Red
- #5271ST - White
- #5272ST - Blue
- #5273ST - Yellow
- #5275ST - Black
- #5276ST - Silver
- #5277ST - Gold
- #5278ST - Orange
- #5279ST - Green

## ANGLED LOG TEE MARKERS

4 ¼"H x 4"W with 3 ½" spike (2.6 lbs.).



- #406800 - Red
- #406801 - White
- #406802 - Blue
- #406803 - Yellow
- #406804 - Black
- #406805 - Green

## SLIM LIMB TEE MARKERS

These attractive three dimensional tee markers are molded from extremely strong and durable resins. Two spikes in each marker to keep them lined up the right way. 9" Long, 2" Wide, 2½" High (1.5 lbs.).

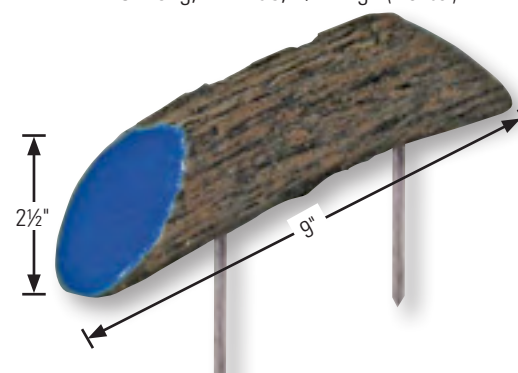

- #T009109R - Red
- #T009109W - White
- #T009109B - Blue
- #T009109Y - Yellow
- #T009109BLK - Black
- #T009109G - Green

## LOG TEE MARKERS

These attractive three dimensional tee markers are molded from extremely strong and durable resins. Two spikes in each marker to keep them lined up the right way. 7¾" Long, 3½" Wide, 2¾" High (1.85 lbs.).

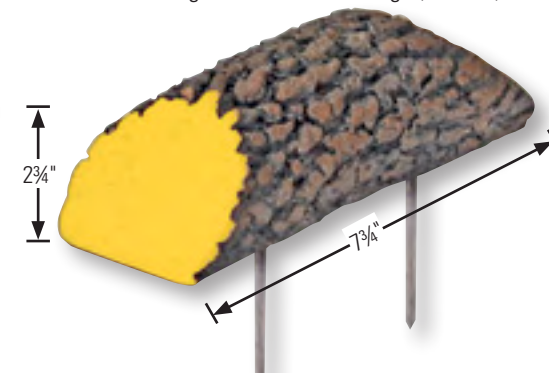

- #T001R - Red
- #T001W - White
- #T001B - Blue
- #T001Y - Yellow
- #T001BLK - Black
- #T001G - Green

Ask us how you can personalize log tee markers with custom colors or your course's logo.

# BROKEN TEE CADDIES

## BROKEN TEE BASKET

- One Piece Construction
- Weather Resistant
- Non-Toxic to Plants & Soil
- Nests for easy storage (.5 lbs.).

#405219 - Green Only (Box of 18)

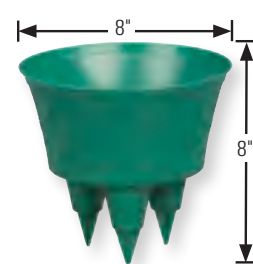

## BROKEN TEE CADDIE

- Sleek cone-shape design minimizes footprint.
- Powder-coated steel construction.
- Includes "Broken Tee" decal and 5" spike. 6"H (1 lbs.).

- #19000ST - Black
- #19015ST - Yellow
- #19025ST - Red
- #19050ST - Green
- #19075ST - Blue
- #19085ST - Orange
- #19095ST - White



## BROKEN TEE BOX

Made from durable maintenance free recycled plastic. Sure to keep your tee boxes clean and mower blades sharp. Drainage allows for sand and water to sift through the bottom. Size: 6½"W x 8¼"L (1½ lbs.).

- #405215 - Green
- #405216 - Brown
- #405217 - Black
- #405223 - Driftwood
- #405224 - Walnut

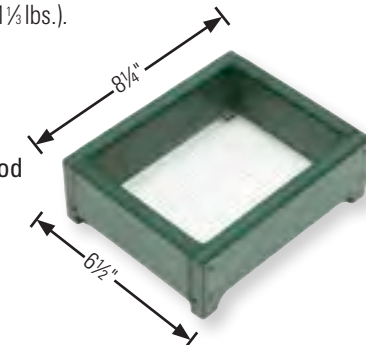



## SCRUSHER® & DELUXE SCRUSHER®

- Three separate bottom brushes now with softer, longer-lasting nylon bristles.
- Two side brushes with gentler bristles that don't scratch the sides of shoes.
- The wider design of the Deluxe Scrusher® offers more stability and extra space between lower bristles to prevent buildup.
- Durable cast aluminum, powder-coated base included on the Deluxe model.
- Mounting stakes sold separately, four per unit.

#14100ST	Scrusher Spike Brush
#14000ST	Deluxe Scrusher Spike Brush
#14050ST	Deluxe Scrusher Handle
#14102ST	Scrusher Bottom Brush (3 needed)
#14103ST	Scrusher Side Brush (2 needed)
#14106ST	6" Asphalt Mounting Stake (4 needed)
#14124ST	18" Turf Mounting Stake (4 needed)

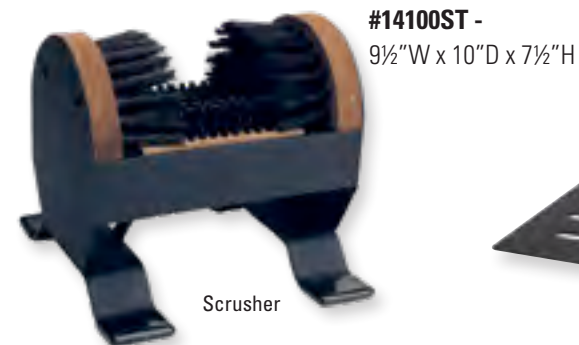

#14050ST -  
3 1/2" W x 10 1/2" H

## SPIKE CLEANERS



### ▶ RECYCLED PLASTIC SPIKE BRUSH

Made from low maintenance recycled plastic, this brush can either bolt down to solid surfaces or spike into grass. 5 3/4" W x 5 1/4" L

- #C011 - Complete Spike Brush Unit
- #C008 - Replacement Base Brush
- #C009 - Replacement Side Brush (2 required if replacing both sides)

### ▶ DUO-KLEENER™ SPIKE BRUSH STAND

- Put this useful spike cleaner to work wherever it's needed most.
- Anchors in asphalt or in the ground with turf stakes.
- Includes stand, brushes, hardware and three 3 1/2" spikes (17.6 lbs.).

#36650ST

### ▶ SPIKE BRUSH

Efficient synthetic bristles with a durable, cast aluminum, powder-coated base. Includes four 3 1/2" stakes. 5 3/8" W x 5 1/8" L (1.3 lbs.).

- #14750ST - Black
- #14450ST - Green
- #14350ST - Red
- #14252ST - Replacement Spike Brush

### ▶ SPIKE BRUSH WITH CONSOLE MOUNT

#36156BST

### ▶ SPIKE BRUSH WITH VERTICAL POST MOUNT

#402412



## NEET KLEET® ELECTRIC SPIKE CLEANER

- Molded plastic body eliminates unsightly paint chipping, fading and rusting common to other shoe cleaners!
- Dual handles provide a stable platform while cleaning golf shoes.
- Push button in handle activates machine from 110V outlet.
- All debris is captured in the removable grass receptacle for daily maintenance.
- Rotating nylon brushes clean sides, soles, heels and toes.
- Nylon Brush suitable for steel or alternative spikes.
- Weight: 38 lbs., Size: 32" L x 15 1/2" W x 32" H

#WGL70G - Green

#WGL70T - Tan

\*\*Also available in 220V units.

#WG019S - Replacement Brush Set (3 Brushes)

#WG065 - Replacement Motor

#WG050 - Replacement Belt

#WGL70-P10 - Push Button Switch



## COMPRESSED AIR SPIKE CLEANER



This console offers convenient spike cleaning while keeping your facility neat and tidy. Made from durable recycled plastic lumber, it is used with compressed air to clean the bottom of the golfers' shoes. Clippings are contained by the high wrap around walls and a 90 degree wand allows easy cleaning without uncomfortable bending by the golfer. Contained clippings fall through a bottom grate into a removable tray for easy disposal. Each unit comes with Deluxe 20" Long Air Blow Gun. Air compressor sold separately.

Weight: 80 lbs. Size: 32" L x 19" W x 40" H

- #C055-G - Green
- #C055-BRN - Brown
- #C055-BLK - Black
- #C055-DRT - Driftwood
- #C055-WN - Walnut
- #C055-C - Custom

Logos can be included on the side or front of this unit.

Color choices for all recycled plastic products

Green

Brown

Black

Driftwood

Walnut

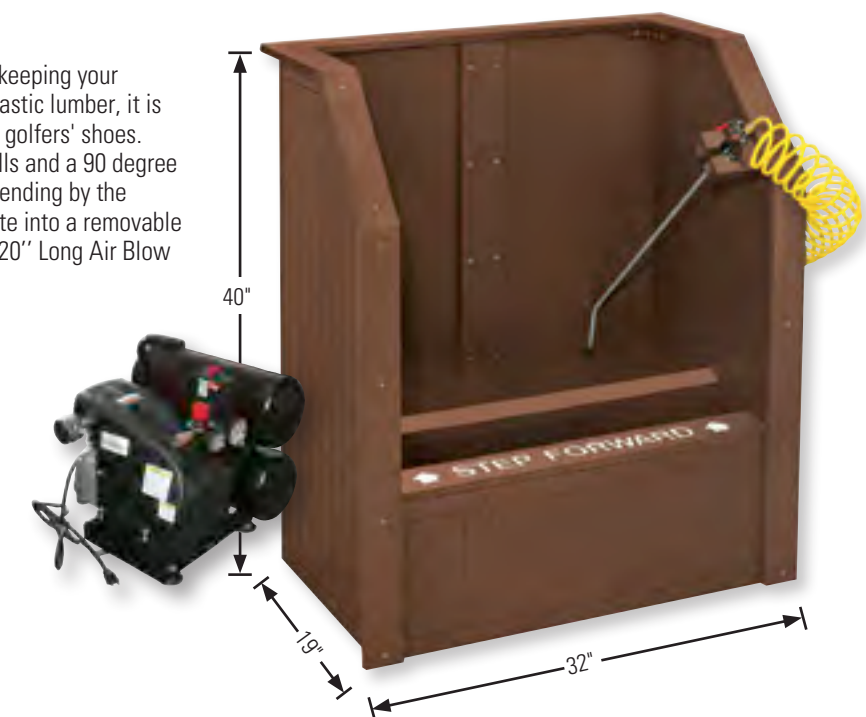

Order online 24/7 @ [www.wittekgolf.com](http://www.wittekgolf.com)



# ROPE AND CHAIN STAKES 2" X 2"

Maintenance free and made with recycled material.  
Available in a variety of sizes and designs to fit your needs.

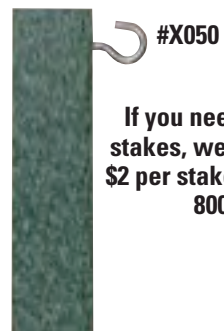

If you need hooks on your stakes, we can do it for only \$2 per stake! Give us a call at 800-869-1800

## BASIC

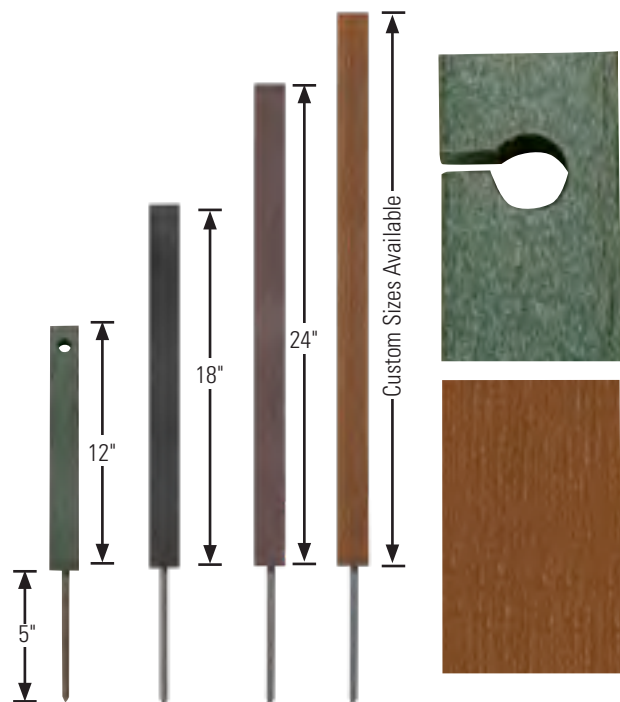

### Basic - Standard Colors

	12"	18"	24"
Green - Hole	#405600-1B	#405601-1B	#405602-1B
Green - Speed Slot	#405600-1C	#405601-1C	#405602-1C
Black - Hole	#405610-1B	#405611-1B	#405612-1B
Black - Speed Slot	#405610-1C	#405611-1C	#405612-1C
Brown - Hole	#405620-1B	#405621-1B	#405622-1B
Brown - Speed Slot	#405620-1C	#405621-1C	#405622-1C

### Basic - Premium Colors

	12"	18"	24"
Walnut - Hole	#405630-1B	#405631-1B	#405632-1B
Walnut - Speed Slot	#405630-1C	#405631-1C	#405632-1C

## TRADITIONAL

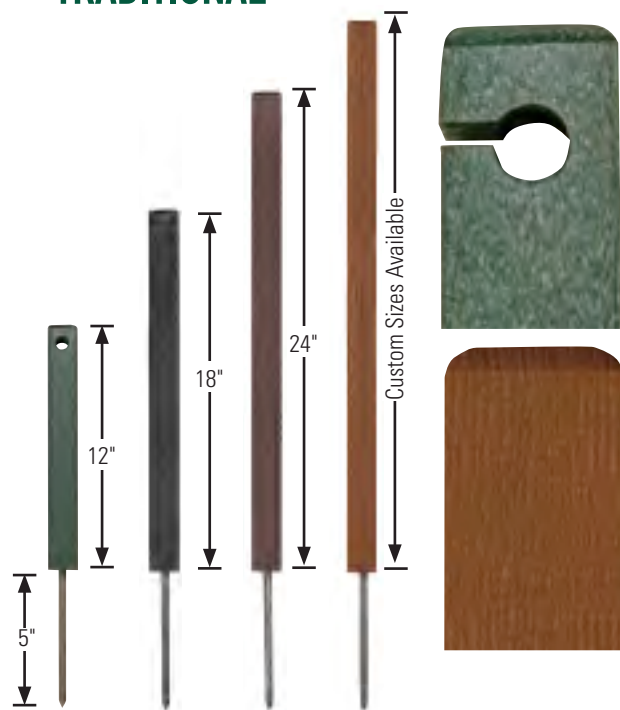

### Traditional - Standard Colors

	12"	18"	24"
Green - Hole	#405600-2B	#405601-2B	#405602-2B
Green - Speed Slot	#405600-2C	#405601-2C	#405602-2C
Black - Hole	#405610-2B	#405611-2B	#405612-2B
Black - Speed Slot	#405610-2C	#405611-2C	#405612-2C
Brown - Hole	#405620-2B	#405621-2B	#405622-2B
Brown - Speed Slot	#405620-2C	#405621-2C	#405622-2C

### Traditional - Premium Colors

	12"	18"	24"
Walnut - Hole	#405630-2B	#405631-2B	#405632-2B
Walnut - Speed Slot	#405630-2C	#405631-2C	#405632-2C

We can make all of our stakes any color, any size, any time.

## BEVELED

### Beveled - Standard Colors

	12"	18"	24"
Green - Hole	#405600-3B	#405601-3B	#405602-3B
Green - Speed Slot	#405600-3C	#405601-3C	#405602-3C
Black - Hole	#405610-3B	#405611-3B	#405612-3B
Black - Speed Slot	#405610-3C	#405611-3C	#405612-3C
Brown - Hole	#405620-3B	#405621-3B	#405622-3B
Brown - Speed Slot	#405620-3C	#405621-3C	#405622-3C

### Beveled - Premium Colors

	12"	18"	24"
Walnut - Hole	#405630-3B	#405631-3B	#405632-3B
Walnut - Speed Slot	#405630-3C	#405631-3C	#405632-3C



## EMPIRE

### Empire - Standard Colors

	12"	18"	24"
Green - Hole	#405600-4B	#405601-4B	#405602-4B
Green - Speed Slot	#405600-4C	#405601-4C	#405602-4C
Black - Hole	#405610-4B	#405611-4B	#405612-4B
Black - Speed Slot	#405610-4C	#405611-4C	#405612-4C
Brown - Hole	#405620-4B	#405621-4B	#405622-4B
Brown - Speed Slot	#405620-4C	#405621-4C	#405622-4C

### Empire - Premium Colors

	12"	18"	24"
Walnut - Hole	#405630-4B	#405631-4B	#405632-4B
Walnut - Speed Slot	#405630-4C	#405631-4C	#405632-4C





# HAZARD AND OB STAKES 2" X 2"

Maintenance free and made with recycled material.  
Available in a variety of sizes and designs to fit your needs.

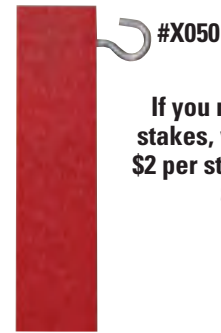

If you need hooks on your stakes, we can do it for only \$2 per stake! Give us a call at 800-869-1800

## BASIC

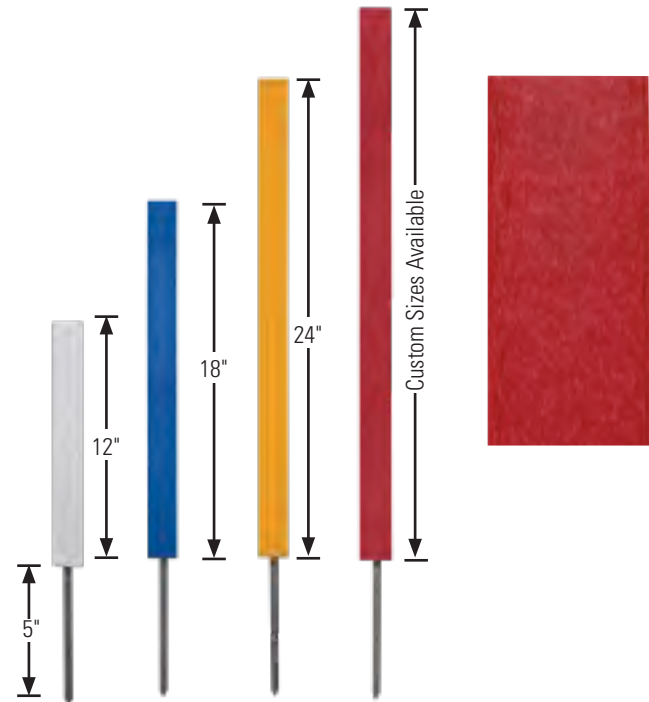

	Basic		
	12"	18"	24"
Yellow	#405635-1	#405636-1	#405637-1
Red	#405640-1	#405641-1	#405642-1
White	#405645-1	#405646-1	#405647-1
Blue	#405650-1	#405651-1	#405652-1

## TRADITIONAL

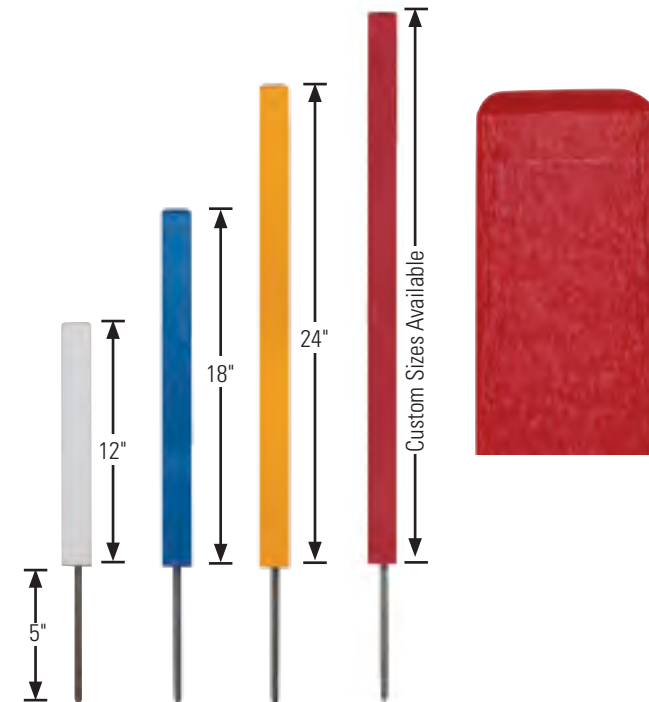

	Traditional		
	12"	18"	24"
Yellow	#405635-2	#405636-2	#405637-2
Red	#405640-2	#405641-2	#405642-2
White	#405645-2	#405646-2	#405647-2
Blue	#405650-2	#405651-2	#405652-2

We can make all of our stakes any color, any size, any time.

## BEVELED

	Beveled		
	12"	18"	24"
Yellow	#405635-3	#405636-3	#405637-3
Red	#405640-3	#405641-3	#405642-3
White	#405645-3	#405646-3	#405647-3
Blue	#405650-3	#405651-3	#405652-3

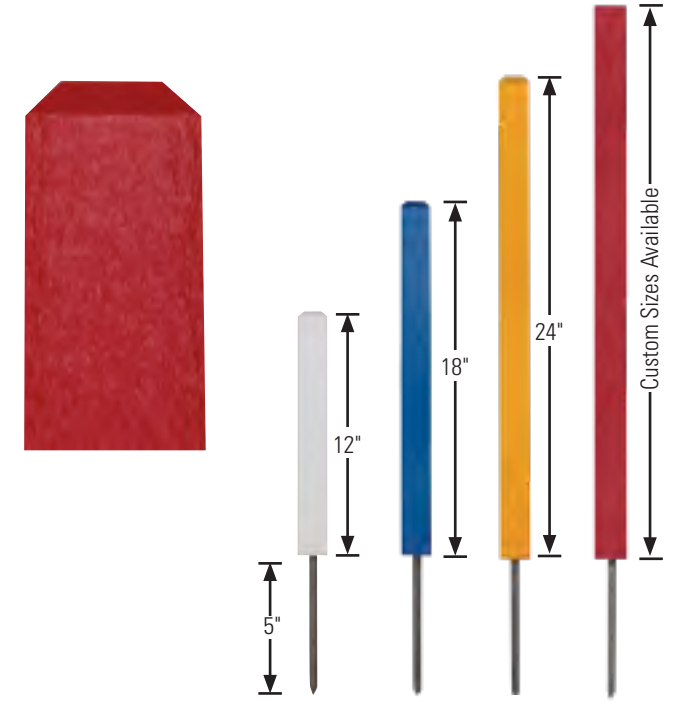

## EMPIRE

	Empire		
	12"	18"	24"
Yellow	#405635-4	#405636-4	#405637-4
Red	#405640-4	#405641-4	#405642-4
White	#405645-4	#405646-4	#405647-4
Blue	#405650-4	#405651-4	#405652-4

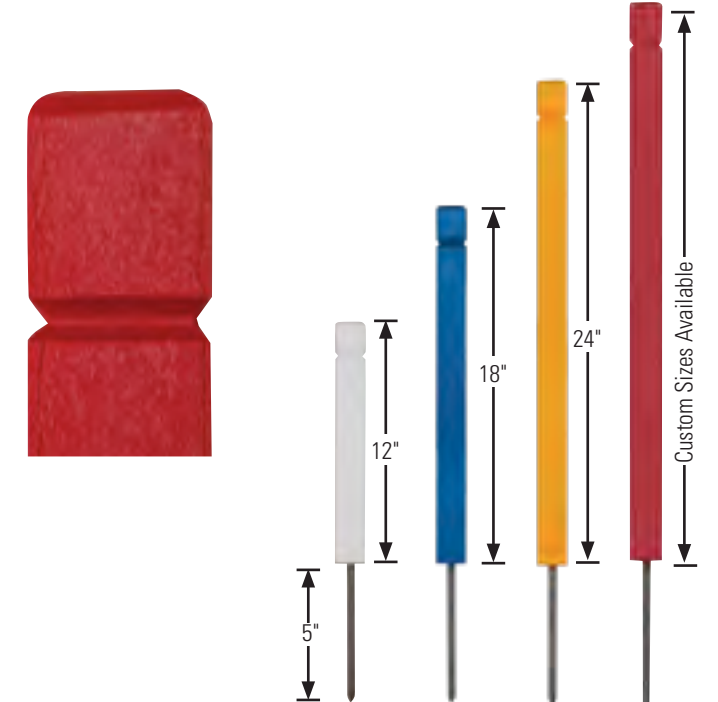



# DIRECTIONAL ASSISTANCE

## ▶ ROPE POSTS & TRAFFIC DIVERTERS

Maintenance free and made with recycled material, each model includes a 2 spike base and is available in multiple lengths and colors. All posts are 4" x 4". If you want a hole drilled please specify, these are sold without.

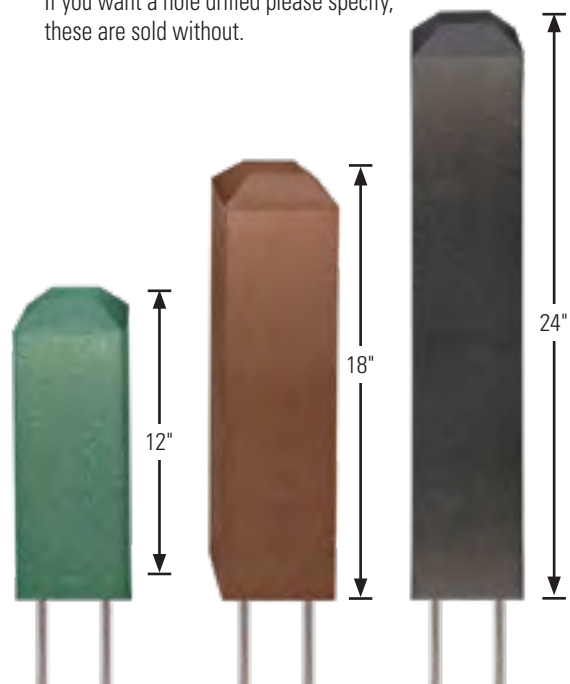

Standard Colors			
	12"	18"	24"
Green	#405650	#405651	#405652
Brown	#405653	#405654	#405655
Black	#405656	#405657	#405658
White	#90569	#90570	#90571
Driftwood	#405681	#405682	#405683

Premium Colors			
	12"	18"	24"
Walnut	#90574-WN	#90575-WN	#90576-WN



## ▶ LAMINATED PLASTIC DISTANCE MARKERS

Made from extremely durable laminated plastic, these markers will withstand the test of time on your course! Stock markers are perfect for the fairway, and custom messages can be added to make OB, hazards, or no cart areas! Made from laminated plastic posts we can engrave any custom number or message you may need! 29½" H x 3½" W (10 lbs.)

- #F136R - Red w/ White 100
- #F136W- White w/ Black 150
- #F136B- Blue w/ White 200
- #F136Y- Yellow w/ Black 250
- #F136C- Custom

## ▶ SCATTER BARRIER

Perfect design and functionality for a temporary solution, each barrier directs traffic around your course, wherever you need it, whenever you need it. 4' 24 lbs., 6' 36 lbs.

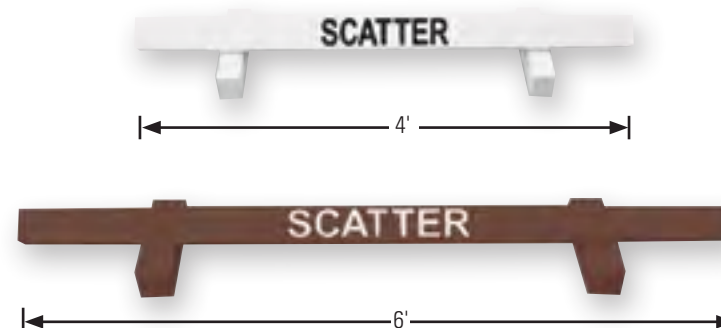

	4 Foot	6 Foot
Green	#405665-4G	#405665-6G
Black	#405665-4BLK	#405665-6BLK
Brown	#405665-4BRN	#405665-6BRN
White	#405665-4W	#405665-6W
Driftwood	#405665-4DRT	#405665-6DRT

Premium Colors		
	4'	6'
Walnut	#405665-4WN	#405665-6WN



## ▶ BUCKET OF STAKES

25 white or green 8" recycled plastic stakes with spike. Includes 3.5" end cap for the top of the stake. Cap options are Green, Red, Blue, Black and White. (19 lbs.).

Cap Color	Green Stake	White Stake
Green	#405841-2	#405841-1
Red	#405842-2	#405842-1
Blue	#405840-2	#405840-1
Black	#405843-2	#405843-1
White	#405844-2	#405844-1



## ▶ HOLLOW BRAID ROPE

Perfect for maintaining a consistent look all around your clubhouse and course. Available in 1/4" and 1/2" sizes.



Size	Hunter Green	Hunter Green/White	White	Black	Yellow
1/4" x 1000'	#400191	#400192	#400193	#400190	#400194
1/2" x 500'	#400196	#400197	#400198	#400195	#400199

## ▶ ROPE FIDS

Plastic "Fid" for joining or putting "Eyes" in the end of hollow braid rope.

- #F1891/4 - 1/4"
- #F1891/2 - 1/2"





## BUNKER RAKES

### ▶ ECONOMY RAKES

15" Economy Bunker Rake with/ 54" Green Ultra Light Steel Handle (15 lbs.).

**#11665ST**

### ▶ TOUR-LITE™ RAKES

15" Tour Lite Bunker Rake with 54" Green Ultra Light Steel Handle (15 lbs.).

**#12375ST**

### ▶ TOUR PRO™

- 20" and 25" heads ensure tracks are covered with minimum effort, while pioneering design generates tournament quality surfaces.
- When durability is a must, the exclusive Gator Grip™ Handle is your best option, available in both 60" and 72" lengths.
- A single self-tapping screw (included) is all you need for assembly.

**#11760ST** - 20" Tour Pro Bunker Rake  
w/ 54" Green Aluminum Handle (21 lbs.)

**#11720ST** - 20" Tour Pro Bunker Rake  
w/ 60" Green Gator Handle (21 lbs.)

**#11770ST** - 25" Tour Pro Bunker Rake  
w/ 72" Green Gator Handle (26 lbs.)

### ▶ TOUR SMOOTH™ II

- Smooths both fine and coarse sand into perfect playing conditions quickly and easily.
- Pair the Tour Smooth™ II with the exclusive 60" Gator Grip™ Handle for a level of performance unmatched by any of the competitors.
- A single self-tapping screw (included) is all you need for assembly.

**#11800ST** - 15" Tour Smooth II Bunker Rake  
w/ 54" Green Composite Handle (22 lbs.)

**#11820ST** - 15" Tour Smooth II Bunker Rake  
w/ 60" Green Gator Grip Handle (24 lbs.)

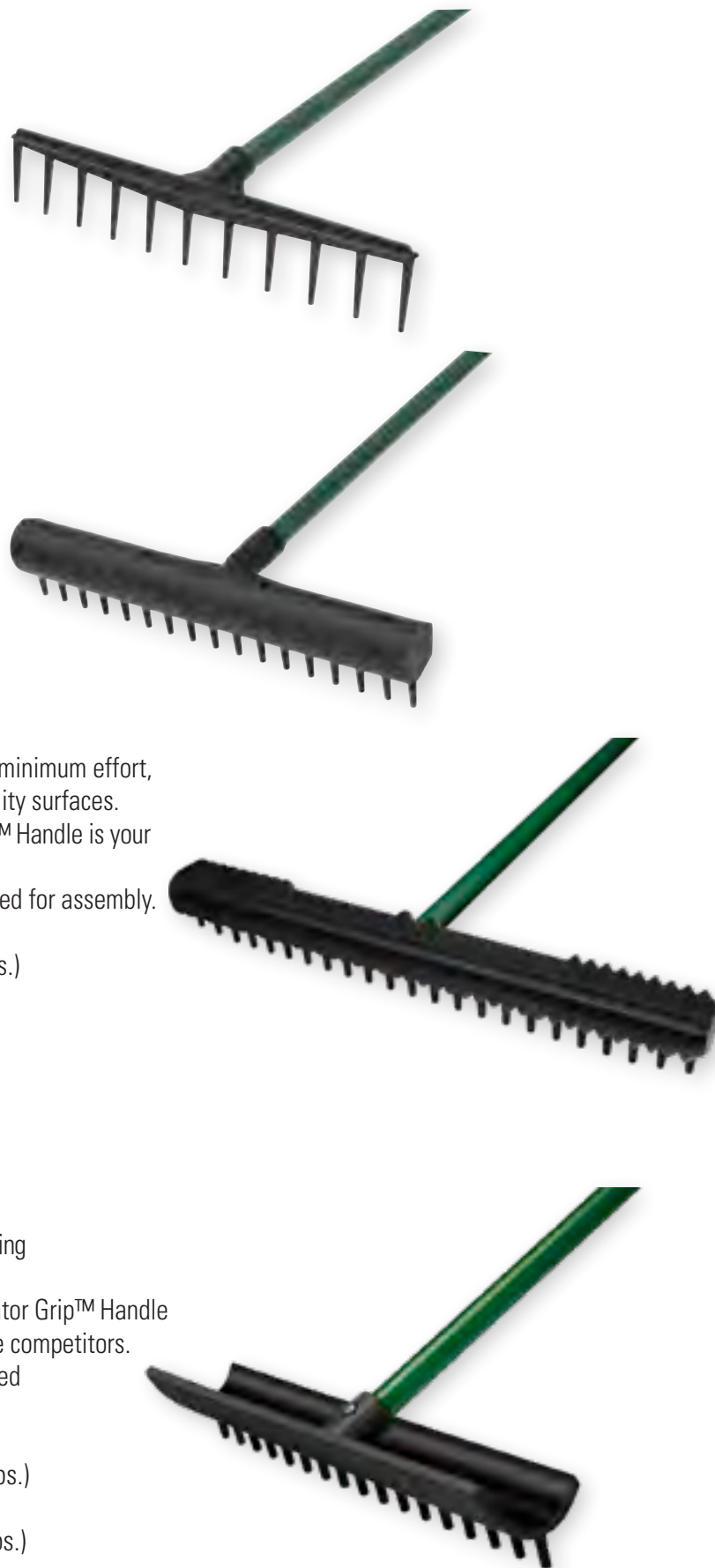

## WITTEK PRO LINE RAKES

### ▶ PRO LINE RAKES

- Round tapered edges on each end for a clean finish.
- High-density lightweight polyethylene head.
- Extra strong - guaranteed "no splinter" composite handle.

**#401000** - 25" head w/ 72" handle

**#401001** - 17" head w/ 54" handle





# VINYL GUARD<sup>®</sup> golf

SKU	Description	Packaging
#30-FS-5000W	½" White Vinyl Roll Renews 30 Sticks	250 ft. per roll
#30-FS-5000Y	½" Yellow Vinyl Roll Renews 30 Sticks	250 ft. per roll
#30-FS-5000B	½" Black Vinyl Roll Renews 30 Sticks	250 ft. per roll
#30-FS-5000BL	½" Blue Vinyl Roll Renews 30 Sticks	250 ft. per roll
#30-FS-5000G	½" Green Vinyl Roll Renews 30 Sticks	250 ft. per roll
#30-FS-5000R	½" Red Vinyl Roll Renews 30 Sticks	250 ft. per roll

SKU	Description	Packaging
#30-FS-7550W	¾" White Vinyl Roll Renews 30 Sticks	250 ft. per roll
#30-FS-7550Y	¾" Yellow Vinyl Roll Renews 30 Sticks	250 ft. per roll
#30-FS-7550B	¾" Black Vinyl Roll Renews 30 Sticks	250 ft. per roll
#30-FS-7550BL	¾" Blue Vinyl Roll Renews 30 Sticks	250 ft. per roll
#30-FS-7550G	¾" Green Vinyl Roll Renews 30 Sticks	250 ft. per roll
#30-FS-7550R	¾" Red Vinyl Roll Renews 30 Sticks	250 ft. per roll

SKU	Description	Packaging
#30-RH-1000G	1" Green Rake Handle Renews 50 Handles	250 ft. per roll
#30-RH-1000Y	1" Yellow Rake Handle Renews 50 Handles	250 ft. per roll
#30-RH-1000B	1" Brown Rake Handle Renews 50 Handles	250 ft. per roll

SKU	Description	Packaging
#AS-77	3M Super 77 Multi-Purpose Adhesive Spray	1 Per Box
#VT-1100	High Temperature High Velocity Heat Gun	1 Per Box

### ▶ FLEX STAKES

The ultimate in mow-over stakes, flexible and durable, Flex Stakes are color-impregnated and are low maintenance installation, and they float! Flex Set and Anchors not included.

Color	17½"	24"
White	#42778	#42884
Yellow	#42883	#42887
Blue	#42880	#42888
Green	#42881	#42889
Red	#42882	#42890
Red/Yellow	#42779	#42891



### ▶ FLEX ANCHOR

High visibility surface ring sheds water and dirt. Automatically locks stake in place.

#42960 - Black

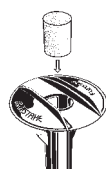

## YARDAGE MARKER SYSTEMS

Made of super durable ¾" engraved plastic, these fairway yardage markers are virtually unbreakable. Your choice of 15" round or 8" x 12" rectangular. May also be used as tee yardage markers and customized with your logo. Comes with two 4" spikes.

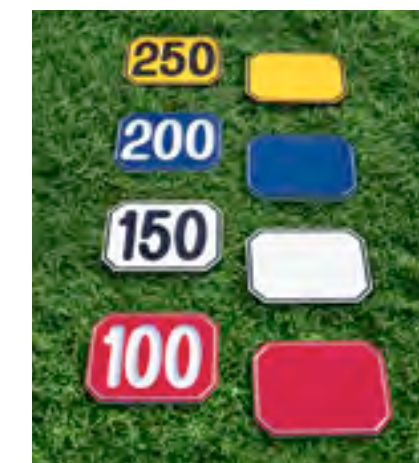

Color	8" Round Plain or Numbered	15" Round Plain or Numbered	8" x 12" Rectangular Plain or Numbered
Red w/ White #'s	#405851	#405853	#405852
White w/ Black #'s	#405856	#405858	#405857
Blue w/ White #'s	#405861	#405863	#405862
Yellow w/ Black #'s	#405866	#405868	#405867
Black w/ White #'s	#405871	#405873	#405872
Green w/ White #'s	#405876	#405878	#405877



### ▶ THE KIRBY MARKER SYSTEM

- Choose the complete Kirby Marker System used by thousands of courses worldwide to speed up play, build revenue and increase golfer satisfaction.
- Patented collapsible markers in red, white, blue, yellow, green and black.

#59405 - Custom Marker

#59409 - Anchor Collar Tab

#F110AP - Anchor Pipe

- #59400 - Red
- #59401 - White
- #59402 - Blue
- #59403 - Yellow
- #59404 - Green
- #59406 - Black

- #59400-1 - Red Collar
- #59401-1 - White Collar
- #59402-1 - Blue Collar
- #59403-1 - Yellow Collar
- #59404-1 - Green Collar
- #59406-1 - Black Collar



### ▶ MUSHROOM MARKERS

These markers have 14" diameter tops that collapse! This allows them to stand higher in the fairway for greater visibility but set down under the load of the lawn mower and reduce the bounce of golf balls compared to hard surfaces. Available in red, white, and blue.



- #400200 - Red Marker - Whole Unit
- #400201 - White Marker - Whole Unit
- #400202 - Blue Marker - Whole Unit

- #400204 - Red Marker - Top Only
- #400205 - White Marker - Top Only
- #400206 - Blue Marker - Top Only

#400203 - Marker Base Only



# DIVOT BOTTLE STORAGE



## DIVOT MIX BOTTLES

- A - #18802 - Seed and Soil Bottle Only 14" tall
- B - #41333 - 35 oz top Fill, Curved Neck 14" tall
- C - #41313 - 45 oz Bottom Fill, Curved Grip Neck 14" tall
- D - #41370 - Kaddie clip 13" tall
- E - #41299 - Divot Bottle w/ Handle



## DIVOT BOTTLE HOLDER W/OUT HANDLE



Position this divot mix bottle holder next to the tee markers on your busy par 3 tee boxes to encourage your golfers to fill their divots after teeing off! Comes with two spikes for easy ground mounting! Holder sold without divot mix bottles. This unit fits bottles B and C shown on page 110.

12½"L x 6"W x 5½"H ( 3.5 lbs.)

- #F200BLK - Black
- #F200BRN - Brown
- #F200GRN - Green
- #F200DRT - Driftwood
- #F200WN - Walnut
- #F200C - Custom

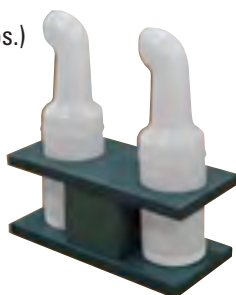

## SMALL DIVOT BOTTLE BOX



- Holds 12 bottles
- Compact. Portable. Rugged.
- Bottles not included.
- Gas shocks now included on each unit so lid doesn't slam when you shut it.

- 16"H x 18"W x 13"D ( 20 lbs.)
- #405365 - Green
- #405366 - Brown
- #405367 - Black
- #405368 - Driftwood
- #405366WN - Walnut
- #405366C - Custom



## DIVOT BOTTLE HOLDER W/ HANDLE



Position this long handle bottle holder where divots fail to get filled in your fairways and on your tee boxes. The long handle allows a mower operator to easily pick up and mow over! Holder sold without divot mix bottles. This unit fits bottles B and C shown on page 110.

12½"L x 6"W x 31"H ( 4.5 lbs.)

- #F100BLK - Black
- #F100BRN - Brown
- #F100GRN - Green
- #F100DRT - Driftwood
- #F100WN - Walnut
- #F100C - Custom



## SMALL DIVOT BOTTLE CADDIE



Model holds 12 bottles. Bottles not included.

- 17"W x 18"H x 21½"D ( 32 lbs.)
- #405360 - Green
- #405361 - Brown
- #405362 - Black
- #405363 - Driftwood
- #405361WN - Walnut
- #405361C - Custom



Color choices for all recycled plastic products

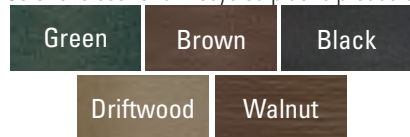

# DIVOT BOTTLE STORAGE



## PORTABLE BOTTLE HOLDER



This bottle holder design was inspired by our bag stand, meaning it's just as easy to move! This unit fits bottles B and C shown on page 110. Fits 9 bottles.

- #300GRN - Green
- #300BRN - Brown
- #300BLK - Black
- #300DRT - Driftwood
- #300WN - Walnut
- #300CST - Custom

## MEDIUM DIVOT BOTTLE RACK



• Holds 24 bottles.  
• Comes with 4" x 4" x 60" posts for permanent in-ground installations.  
• Convenient leveling feet for placement on surfaces also available upon request for an additional charge.  
• Bottles not included.  
• This unit fits bottles B and C shown on page 110.

- 41"W x 60"H x 16"D ( 100 lbs.)
- #405375 - Green
- #405376 - Brown
- #405377 - Black
- #405379 - Driftwood
- #405376WN - Walnut
- #405376C - Custom

## MEDIUM DIVOT BOTTLE BOX



• Stylish heavy-built frame housing.  
• Holds 24 bottles.  
• Bottles not included.  
• Gas shocks now included on each unit so lid doesn't slam when you shut it.  
• This unit fits bottles B and C shown on page 110.

- 24" x 17" x 36" ( 72 lbs.)
- #405370 - Green
- #405371 - Brown
- #405372 - Black
- #405374 - Driftwood
- #405371WN - Walnut
- #405371C - Custom



D - #41370 - Kaddie clip 13" tall



## KADDIE CLIP BOX



Holding 30 kaddie clip bottles has never been easier than it is with our brand new kaddie clip box! Made from recycled plastic lumber. This unit fits bottle D shown on page 110.

- 17"W x 18"H x 20½"D ( 32 lbs.)
- #T318BLK - Black
- #T318BRN - Brown
- #T318GRN - Green
- #T318DRT - Driftwood
- #T318WN - Walnut
- #T318CST - Custom

## KADDIE CLIP BOTTLE HOLDER



This box holds 40 kaddie clips and makes it extremely convenient for your walkers to replenish their sand and seed tubes. Made from recycled plastic, these boxes require no maintenance and make your maintenance crews jobs easier by letting your golfers do the work!  
Holder sold without divot mix bottles. This unit fits bottle D shown on page 110. Gas shocks now included on each unit so lid doesn't slam when you shut it

- #T317BLK - Black
- #T317BRN - Brown
- #T317GRN - Green
- #T317DRT - Driftwood
- #T317WN - Walnut
- #T317C - Custom



# DIVOT BOTTLE STORAGE



## ▶ MINI A FRAME DIVOT BOTTLE HOLDER



Storing and moving 20 divot mix bottles has never been easier! This A frame style holder is made from recycled plastic and is perfect for high traffic areas on your course where guests can replace empty bottles with full ones. When you need to move it, simply fold it up, grab one of the side handles, and carry it where you need to! This unit fits bottles B, and C shown on page 110.

- #T307BLK – Black
- #T307BRN – Brown
- #T307GRN – Green
- #T307DRT – Driftwood
- #T307WN – Walnut
- #T307C – Custom



- B - #41333** - 35 oz top Fill, Curved Neck 14" tall
- C - #41313** - 45 oz Bottom Fill, Curved Grip Neck 14" tall

## ▶ MEGA A FRAME BOTTLE HOLDER



Storing and moving 32 divot mix bottles has never been easier! This A frame style holder is made from recycled plastic and is perfect for high traffic areas on your course where guests can replace empty bottles with full ones. When you need to move it, simply fold it up, grab one of the side handles, and carry it where you need to! This unit fits bottles B, and C shown on page 110.

- #T308BLK – Black
- #T308BRN – Brown
- #T308GRN – Green
- #T308DRT – Driftwood
- #T308WN – Walnut
- #T308C – Custom



- B - #41333** - 35 oz top Fill, Curved Neck 14" tall
- C - #41313** - 45 oz Bottom Fill, Curved Grip Neck 14" tall

## ▶ ANGLED DIVOT BOTTLE HOLDER



This super sturdy unit holds 40, 1 quart divot mix bottles and is made from recycled plastic. Also featuring an empty bottle tray on the bottom, this holder is perfect for the first tee, the turn, or any other high traffic area on your course where riders can exchange empty bottles for ones with plenty of sand & seed! Holder sold without divot mix bottles. This unit fits bottles B, and C shown on page 110.

- #T327BLK – Black
- #T327BRN – Brown
- #T327GRN – Green
- #T327DRT – Driftwood
- #T327WN – Walnut
- #T327C – Custom



- B - #41333** - 35 oz top Fill, Curved Neck 14" tall
- C - #41313** - 45 oz Bottom Fill, Curved Grip Neck 14" tall



800-869-1800



# DIVOT MIX STORAGE

Give a different look to your divot mix boxes with one of these innovative models. Made with recycled material, each model is designed to be appealing and functional.



See page 116 for Windy City trash container and see page 42 for Windy city club washer!

## ▶ WINDY CITY DIVOT MIX BOX

- Divot Mix and Trash container includes liners and lids
- UV - Resistant
- 8 - Gallons ( 30 L )
- Container Dimensions: 16"x 16"W x 19"H
- Attractive side panels dress up the range or tee area

- #4053GN - Green
- #4053BN - Brown
- #4053BK - Black
- #T300SCOOP - Replacement Scoop

## ▶ ROUND DIVOT MIX CONTAINERS



Weather proof 100% recycled plastic lumber round Divot Mix Containers. Features a recycled plastic frame, three pointed slats for anchoring and a heavy duty recycled plastic lid. All units include easily removable plastic bucket and scoop.

- 5 gal: 18" x 18" x 18" (29 lbs.)
- 10 gal: 21½" x 21½" x 23" (38 lbs.)
- 5 Gallon
- 10 Gallon
- #405310 - Green
- #405311 - Brown
- #405312 - Black
- #405313 - Driftwood
- #405311WN - Walnut
- #405311C - Custom
- #405315 - Green
- #405316 - Brown
- #405317 - Black
- #405318 - Driftwood
- #405316WN - Walnut
- #405316C - Custom
- #T300SCOOP - Replacement Scoop



## ▶ DIVOT MIX CONTAINER ON WHEELS



We've added wheels and a removable handle to our T306 Divot Container to make it more mobile. Simply place the handle in the coupling on the back to relocate the unit and then take the handle to the next container. Gas shocks now included on each unit so lid doesn't slam when you shut it. Includes scoop. 18" H x 12½" W x 19" D

- With Wheels (29 lbs.) 5 gal.
- Without Wheels (23 lbs.) 5 gal.
- #T306WHG - Green
- #T306WHBRN - Brown
- #T306WHBLK - Black
- #T306WHDRT - Driftwood
- #T306WHWN - Walnut
- #T306WHC - Custom
- #T306G - Green
- #T306BRN - Brown
- #T306BLK - Black
- #T306DRT - Driftwood
- #T306WN - Walnut
- #T306C - Custom
- #T300SCOOP - Replacement Scoop



## ▶ DIVOT MIX CONTAINERS



These sturdy boxes are made from solid recycled plastic lumber. The board joints are tongue and groove containing divot mix internally. Sturdy legs support the box off the ground to protect turf. Great for busy Par 3 tee boxes or cart bottle refill stations. Gas shocks now included on each unit so lid doesn't slam when you shut it. 28" H x 21" W x 32" L (75 lbs.). Includes scoop.

- #T305G - Green
- #T305BRN - Brown
- #T305BLK - Black
- #T305DRT - Driftwood
- #T305WN - Walnut
- #T305C - Custom
- #T300SCOOP - Replacement Scoop



Color choices for all recycled plastic products

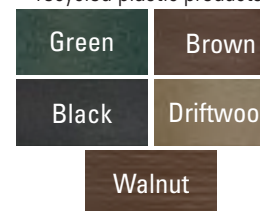

Reorder easily @ [www.wittekgolf.com](http://www.wittekgolf.com)



# TRASH CONTAINERS

## STAINLESS STEEL LITTER CADDIE™ WITH SPIKE



- Stainless ... the name says it all.
- 20-gallon capacity, rust-proof caddy.
  - Designed for long life and easy bag removal.
  - Use heavy-duty steel base or spikes for in-ground installations
  - 17" L x 17"W x 26"H (12 lbs.)

Color	20 gallon 12" spike	20 gallon base
Green	#13975ST	#13978ST
Black	#13995ST	#13998ST
Red	#13950ST	#13953ST

## THE ORIGINAL TAPERED LITTER CADDIE



- Perfectly shaped to properly contain trash contents. 20-gauge steel with rich, durable powder-coat finish.
- 9 Gallon w/ spike or base: 14"L x 14"W x 19"H (9 lbs.)
  - 30 Gallon w/ spike or base: 19 1/2"L x 19 1/2"W x 26"H (20 lbs.)

Color	9 gallon 4 3/4" spike	9 gallon base	30 gallon 12" spike	30 gallon base
Green	#13700ST	#13800ST	#13075ST	#13078ST
Black	#13195ST	#13197ST	#13095ST	#13098ST
Red	#13150ST	#13152ST	#13050ST	#13053ST

## 9 GALLON TUFF GUY™ LITTER CADDIE



- Inexpensive, High-impact resistant
- Conceals unsightly trash
- Low-maintenance—wipes clean
- Returns to original shape if buckled
- Colorfast
- Comes with a removable 6" spike
- 14" x 14" x 16" H (4.75 lbs.)
- Personalize with your course logo

Call For Pricing  
 #T162G - Green  
 #T162BLK - Black

Call For Pricing on personalization

## IN-GROUND TRASH CANS



- These durable trash cans are perfect for "no-touch" golf and deterring animals on your course! Featuring both durable and heavy duty galvanized steel construction, our in-ground trash cans include a noise dampening lid! These trash cans can only be ordered in increments of 8.
- #T325-A-SD – 25 Gallon Complete Unit  
 2 piece unpainted lid

## KOLORCAN™ 32 GALLON RECEPTACLE, WASTE TOP, LINER



- 19"W x 38"H x 19"D (23 lbs.)
- #405230 - Green Solid
  - #405231 - Black Solid

## KOLORCAN™ 42 GALLON RECEPTACLE, DOME TOP, LINER



- 24"W x 38"H (33 lbs.)
- #405220 - Green Solid
  - #405221 - Black Solid



# RECYCLING CENTERS

## FRONT LOAD RECYCLING CENTER



- Made from durable and maintenance free recycled plastic, this is a great looking piece that is available in all of our recycled plastic colors! The wide openings accept a variety of sized trash, bottles and cans, into 32 gallon waste bins that are easily identified with color filled engravings on the front of the unit.
- #C470BLK – Black
  - #C470BRN – Brown
  - #C470GRN – Green
  - #C470DRT – Driftwood
  - #C470WN – Walnut
  - #C470C – Custom



## PULL TOP RECYCLING CENTER



- This attractive recycling container is made of 100% recycled plastic lumber and includes 2 removable 22 gallon bins that lift straight up and out. Color filled engraved wording on the top of each container makes it easy to identify each collection bin.
- 34" high x 38" wide.
- #C465G - Green
  - #C465BRN - Brown
  - #C465BLK - Black
  - #C465DRT - Driftwood
  - #C465WN - Walnut
  - #C465C - Custom



## THE TRIFECTA TRASH & RECYCLE RECEPTACLE



- This unique unit offers a traditional look while both consolidating and promoting recycling at your facility! Three 22-gallon containers make it easy to separate bottles, cans and trash with tons of space for custom logos on and messages on any of the three receptacles! The Trifecta Receptacle is available in any of our recycled plastic color options.
- Size: 56"L x 20"W x 45"H.  
 Weight: 210 lbs.
- #C455GRN - Green
  - #C455BRN - Brown
  - #C455BLK - Black
  - #C455DRT - Driftwood
  - #C455WN - Walnut
  - #C455C - Custom



Color choices for all recycled plastic products

Green	Brown
Black	Driftwood
Walnut	



# TRASH CONTAINERS



## 5 GALLON ROUND TRASH CONTAINER



Weather proof 100% recycled plastic lumber constructed 5 gallon Trash Container. All units include an easily removable plastic bin.

- #T324G - Green
- #T324BRN - Brown
- #T324BLK - Black
- #T324DRT - Driftwood
- #T324WN - Walnut
- #T324C - Custom



## 10 GALLON ROUND TRASH CONTAINER



Weather proof 100% recycled plastic lumber constructed 10 gallon Trash Container. All units include an easily removable plastic bin.

- 21" top diameter x 22½" H (38 lbs.)
- #T322G - Green
- #T322BRN - Brown
- #T322BLK - Black
- #T322DRT - Driftwood
- #T322WN - Walnut
- #T322C - Custom



## WINDY CITY TRASH CONTAINER

- 8 - Gallons (30L)
- Container Dimensions: 16"x16"x19"
- Attractive side panels dress up the range or tee area
- UV - Resistant

- #4054GN - Green
- #4054BN - Brown
- #4054BK - Black
- #778Liner - Replacement Liner



See page 42 for Windy City club washer and see page 113 for Windy City divot mix!

## SQUARE PULL-TOP TRASH RECEPTACLE



Made from low maintenance recycled plastic lumber. Includes a firm internal trash container for easy dumping and is accessed by lifting off the flat top. 10 gallon. 19½" H x 17¼" W x 17¼" D (50 lbs.).

- #T180G - Green
- #T180BRN - Brown
- #T180BLK - Black
- #T180DRT - Driftwood
- #T180WN - Walnut
- #T180C - Custom

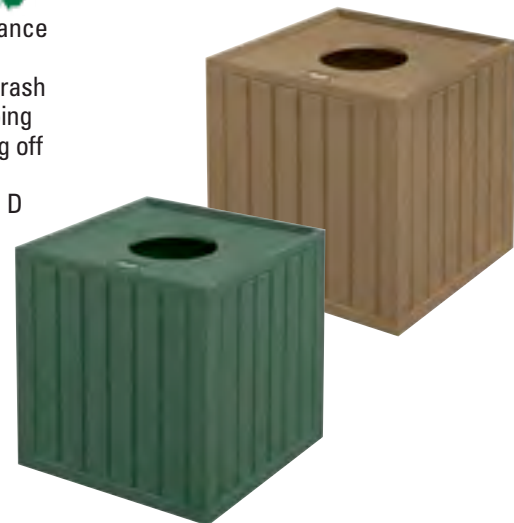

## 22 Gallon Flat Top Arched Trash Can



This great looking trash container includes a 22 gallon trash bin. 20"L x 20"W x 45"H (78 lbs.)

#T189



## 22 GALLON ROUND TRASH RECEPTACLE



These 22 gallon containers feature thinner, tighter slats creating a barrel-style design. Recycled plastic lumber frames and donut lid. Includes an internal trash bin. 20½" x 20½" x 31" H (48 lbs.)

- #T195G - Green
- #T195BRN - Brown
- #T195BLK - Black
- #T195DRT - Driftwood
- #T195WN - Walnut
- #T195C - Custom



## 22 GALLON SQUARE TRASH CAN



These units are all made from low maintenance recycled plastic lumber. Each unit includes a firm internal trash container for easy dumping and is accessed by lifting off the flat top. 36½" H, 18" W and 19" D (70 lbs.). Please call for logo options.

- #T188G - Green
- #T188BRN - Brown
- #T188BLK - Black
- #T188D - Driftwood
- #T188WN - Walnut
- #T188C - Custom

## 22 GALLON MODERN TRASH RECEPTACLE



Spruce up the look of your trash receptacles with these 22 gallon containers! Made from recycled plastic and available in any of our recycled plastic colors, these receptacles give your facility a modern look, with plenty of space for a custom logo! 19"L x 19"W x 43"H (83 lbs.)

- #DDTGRN - Green
- #DDTBRN - Brown
- #DDTBLK - Black
- #DDTDRT - Driftwood
- #DDTWN - Walnut
- #DDTC - Custom



Color choices for all recycled plastic products

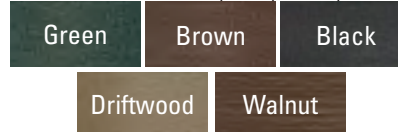

# REPLACEMENT LINERS

## 5 GALLON LINER (ROUND)

15" H x 13"D (2 lbs.)

#M-77-103



## 10 GALLON LINER (ROUND)

17" H x 16"D (3 lbs.)

#XH-1853GR



## 22 GALLON LINER (ROUND)

28" H x 16¼"D (7 lbs.)

#EAGT185BIN



## 32 GALLON LINER (ROUND)

27" H x 22"D (8 lbs.)

#405423





# WATER STATIONS



Maintenance free and made with recycled material. Each model is heavy duty and designed to last. Available in a variety of sizes and designs to fit your needs.



## ▶ RAISED ICE CHEST ENCLOSURE

Model encloses a 54 qt. ice chest. Ice chest is included. Gas shocks now included on each unit so lid doesn't slam when you shut it. 31"W x 24"H x 19"D Weight 67 lbs.  
 #405480 - Green  
 #405481 - Brown  
 #405482 - Black  
 #405483 - Driftwood  
 #405481WN - Walnut  
 #405481C - Custom

Color choices for all recycled plastic products

Green	Brown
Black	Driftwood
Walnut	

## ▶ TRIPOD WATER STATION

Holds 10-gallon cooler (not included). 20"W x 36"H x 20" Weight 25 lbs.  
 #405450 - Green  
 #405451 - Brown  
 #405452 - Black  
 #405453 - Driftwood  
 #405451WN - Walnut  
 #405451C - Custom



## ▶ DELUXE TRIPOD WATER STATION

Foldable and portable base. Design includes lockable door. Holds 10-gallon cooler (not included). 25"W x 67½"H Weight 70 lbs.  
 #405455 - Green  
 #405456 - Brown  
 #405457 - Black  
 #405458 - Driftwood  
 #405456WN - Walnut  
 #405456C - Custom



## ▶ CUP DISPENSER

Our durable dispenser fits brackets on plastic and metal water coolers. Made of plastic. Holds 4¼ ounce cone cup. 13½"H x 2½"W. Weight: 1 lb.  
 A. #42011 B. #54214 C. #45600ST



## ▶ PAPER CUPS - CASE OF 5000

Cone shaped cups hold 4¼ ounces. Color: White. Weight: 25 lbs. #42009

## ▶ METAL CUP DISPENSER REPLACEMENT LID

#45605ST

## ▶ HUNTER GREEN 10 GALLON IGLOO WATER COOLER

16"W x 23"H. Weight: 12 lbs. #42015

## ▶ SPIGOT FOR IGLOO COOLER

#45315ST



## ▶ OPEN BASE WATER STATION

Model designed with versatility in mind, 4-post open-stand housing holds 10-gallon cooler (not included) and includes cup dispenser. 23"W x 70"H x 23"D Weight 125 lbs.  
 #405460 - Green  
 #405461 - Brown  
 #405462 - Black  
 #405464 - Driftwood  
 #405461WN - Walnut  
 #405461C - Custom



## ▶ FULL ENCLOSURE WATER STATION

Holds 10-gallon cooler (not included) and includes cup dispenser, self-closing trash door and liner. 27"W x 70"H x 24"D Weight 145 lbs.  
 #405465 - Green  
 #405466 - Brown  
 #405467 - Black  
 #405468 - Driftwood  
 #405466WN - Walnut  
 #405466C - Custom



## ▶ DOUBLE FULL ENCLOSURE WATER STATION

Housing holds two 10-gallon coolers (not included) and includes cup dispensers, self-closing trash doors and liners. 50"W x 71"H x 24"D Weight 250 lbs.  
 #405475 - Green  
 #405476 - Brown  
 #405477 - Black  
 #405478 - Driftwood  
 #405476WN - Walnut  
 #405476C - Custom



Color choices for all recycled plastic products

Green	Brown	Black
Driftwood	Walnut	



PODIUMS



Color choices for all recycled plastic products

- Green
- Brown
- Black
- Driftwood
- Walnut



► **PODIUM UMBRELLA KIT**

Keep your workspace dry on the rainiest days with this umbrella holder! Easily attaches to your existing Wittek podium. Two pieces per set, umbrella not included.

- #T070BLK - Black
- #T070BRN - Brown
- #T070GRN - Green
- #T070DRT - Driftwood
- #T070WN - Walnut

► **SCORECARD CADDY W/ MOVEABLE BASE**

Similar box structure to our timeless scorecard caddy, this features a self standing and easily moveable base to relocate your scorecards, pencils and tees whenever necessary. Made from recycled plastic and available in all of our colors. Size: 16"L x 16"D x 44"H.

- #405494 - Green
- #405495 - Brown
- #405496 - Black
- #405497 - Driftwood
- #405498 - Walnut
- #405498C - Custom

► **SCORE CARD CADDIE WITH POST**

Hinged lid with dividers makes it perfect for storage of scorecards and pencils. 5' post included. Size: 18"D x 12½"W x 66"H. Weight 45 lbs.

- #405200 - Green
- #405201 - Brown
- #405202 - Black
- #405204 - Driftwood
- #405201WN - Walnut
- #405201C - Custom



► **DIRECTOR'S PODIUM**

This recycled plastic half sized podium is great for tournament directors or starters. The lockable castor wheels make it exceptionally easy to store away at nights and bring out again the next morning! Easily add your logo to the front to make a lasting impression on your guests! Gas shocks now included on each unit so lid doesn't slam when you shut it.

- #T072BLK - Black
- #T072BRN - Brown
- #T072GRN - Green
- #T072DRT - Driftwood
- #T072WN - Walnut
- #T072C - Custom

► **LARGE PODIUM**

The perfect podium for your course, valet and anywhere else at your facility. Made from 100% recycled plastic lumber, with a built-in shelf and an opening top piece for storage. Call to discuss trim, logo, and paneling options! Gas shocks now included on each unit so lid doesn't slam when you shut it. 24"L x 24"W x 49"H (96 lbs.)

- #T071GRN - Green
- #T071BRN - Brown
- #T071BLK - Black
- #T071DRT - Driftwood
- #T071WN - Walnut
- #T071C - Custom

► **ARCH DESIGN PODIUM**

For your greeter or starter, this fantastic looking podium will give you years of use with little to no maintenance required. Made of 100% recycled plastic lumber. Comes with a shelf and a double-door cabinet. Logos can be added. Gas shocks now included on each unit so lid doesn't slam when you shut it. 37" W x 20" L x 51" H Weight 120 lbs.

- Please call to discuss:
- Logo - Paneling - Trim
- #T069A

BENCHES



► **FLAT BACK BENCH**

4' long, 26" wide, 31" high (73 lbs.)  
6' long, 26" wide, 31" high (128 lbs.)

- |                     |                     |
|---------------------|---------------------|
| 4 Foot              | 6 Foot              |
| #405540 - Green     | #405545 - Green     |
| #405541 - Brown     | #405546 - Brown     |
| #405542 - Black     | #405547 - Black     |
| #405523 - Driftwood | #405548 - Driftwood |
| #405544 - Walnut    | #405549 - Walnut    |



► **CONTOURED MALL BENCH**

4'- 48 long, 17" wide, 17" high. (42 lbs.)  
6'- 72" long, 17" wide, 17" high. (63 lbs.)

- |                     |                     |
|---------------------|---------------------|
| 4 Foot              | 6 Foot              |
| #405560 - Green     | #405565 - Green     |
| #405561 - Brown     | #405566 - Brown     |
| #405562 - Black     | #405567 - Black     |
| #405563 - Driftwood | #405568 - Driftwood |
| #405564 - Walnut    | #405569 - Walnut    |



► **HIGH BACK BENCH**

4' long, 26" wide, 34" high. (70 lbs.)  
6' long, 26" wide, 34" high. (105 lbs.)

- |                     |                     |
|---------------------|---------------------|
| 4 Foot              | 6 Foot              |
| #405500 - Green     | #405510 - Green     |
| #405501 - Brown     | #405511 - Brown     |
| #405502 - Black     | #405512 - Black     |
| #405504 - Driftwood | #405514 - Driftwood |
| #405501WN - Walnut  | #405511WN - Walnut  |
| #405501C - Custom   | #405511C - Custom   |



► **MALL BENCH**

4' long, 20" wide, 17" high. (45 lbs.)  
6' long, 20" wide, 17" high. (75 lbs.)

- |                     |                     |
|---------------------|---------------------|
| 4 Foot              | 6 Foot              |
| #405520 - Green     | #405530 - Green     |
| #405521 - Brown     | #405531 - Brown     |
| #405522 - Black     | #405532 - Black     |
| #405524 - Driftwood | #405534 - Driftwood |
| #405521WN - Walnut  | #405531WN - Walnut  |
| #405521C - Custom   | #405531C - Custom   |

► **6' HERITAGE BENCH**

72" long, 25" wide, 36" high.  
Weight 100 lbs.

- #T245G - Green
- #T245BRN - Brown
- #T245BLK - Black
- T245DRT - Driftwood
- #T245WN - Walnut
- #T245C - Custom



Turn your benches into tee signs with tons of custom engraving and color fill options!

See your invoices/statements @ [www.wittekolf.com](http://www.wittekolf.com)



# HUNTINGTON HIGH TOP COLLECTION



## HUNTINGTON HIGH TOP COLLECTION

Wittek & Eagle One's Huntington High Top Collection is the perfect addition to any outdoor patio or 19th hole area. With two seating options and either a bar or high-top table, this collection withstands the test of time. Made from 100% recycled plastic, the bar can be customized with your logo. Call to discuss paneling, trim and customization!



### HUNTINGTON HIGH TOP TABLE

Size: 31" DIA x 43"H.  
Weight: 73 lbs.

- #C320BLK - Black
- #C320BRN - Brown
- #C320GRN - Green
- #C320DRT - Driftwood
- #C320WHT - White
- #C320WVN - Walnut
- #C320C - Custom

### HUNTINGTON BIG BAR

Size: 77"L x 25"W x 42"H  
Weight: 270 lbs.

- #C900BLK - Black
- #C900BRN - Brown
- #C900GRN - Green
- #C900DRT - Driftwood
- #C900WHT - White
- #C900WVN - Walnut
- #C900C - Custom

Color choices for all recycled plastic products

Black	Brown	Green
Driftwood	White	Walnut



### HUNTINGTON HIGH TOP CHAIR

Size: 28"L x 25"W x 47"H.  
Weight: 40 lbs.

- #C321BLK - Black
- #C321BRN - Brown
- #C321GRN - Green
- #C321DRT - Driftwood
- #C321WHT - White
- #C321WVN - Walnut
- #C321C - Custom



### HUNTINGTON BAR STOOL

Size: 13"DIA x 30"H.  
Weight: 13 lbs.

- #C363BLK - Black
- #C363BRN - Brown
- #C363GRN - Green
- #C363DRT - Driftwood
- #C363WHT - White
- #C363WVN - Walnut
- #C363C - Custom

# CAPE COD DINING COLLECTION



## CAPE COD DINING COLLECTION

Wittek & Eagle One's Cape Cod dining collection is available in rectangle and square designs, featuring a simple and timeless look that is sure to impress your guests. Made from 100% recycled plastic, and with a variety of seating options available, the Cape Cod collection is the perfect outdoor dining solution. Umbrella and cushions not included.



### CAPE COD SQUARE DINING TABLE 42"

Size: 42"L x 42"W x 31"H.  
Weight: 114 lbs.

- #C38542BLK - Black
- #C38542BRN - Brown
- #C38542GRN - Green
- #C38542DRT - Driftwood
- #C38542WHT - White
- #C38542WVN - Walnut
- #C38542C - Custom

### CAPE COD SQUARE DINING TABLE 60"

Size: 60"L x 60"W x 31"H.  
Weight: 188 lbs.

- #C3856060BLK - Black
- #C3856060BRN - Brown
- #C3856060GRN - Green
- #C3856060DRT - Driftwood
- #C3856060WHT - White
- #C3856060WVN - Walnut
- #C3856060C - Custom



### CAPE COD DINING TABLE 60"

Size: 60"L x 42"W x 31"H.  
Weight: 131 lbs.

- #C38560BLK - Black
- #C38560BRN - Brown
- #C38560GRN - Green
- #C38560DRT - Driftwood
- #C38560WHT - White
- #C38560WVN - Walnut
- #C38560C - Custom



### CAPE COD STACKABLE CHAIR

Size: 27"L x 20"W x 38"H. Weight: 25 lbs.

- #C362BLK - Black
- #C362BRN - Brown
- #C362GRN - Green
- #C362DRT - Driftwood
- #C362WHT - White
- #C362WVN - Walnut
- #C362C - Custom



### CAPE COD DINING CHAIR

Size: 30"L x 27"W x 41"H. Weight: 33 lbs.

- #C361BLK - Black
- #C361BRN - Brown
- #C361GRN - Green
- #C361DRT - Driftwood
- #C361WHT - White
- #C361WVN - Walnut
- #C361C - Custom



### CAPE COD ROCKER CHAIR

Size: 36"L x 27"W x 40"H. Weight: 40 lbs.

- #C367BLK - Black
- #C367BRN - Brown
- #C367GRN - Green
- #C367DRT - Driftwood
- #C367WHT - White
- #C367WVN - Walnut
- #C367C - Custom



## THE ADIRONDACK SERIES



### ▶ THE ADIRONDACK SERIES

A staple for golf courses, pools and any outdoor facility featuring a timeless look and unmatched quality, made from 100% recycled plastic

### ▶ ROCKER ADIRONDACK

Size: 36"L x 30"W x 34"H.  
Weight: 38 lbs.

- #C431BLK - Black
- #C431BRN - Brown
- #C431GRN - Green
- #C431DRT - Driftwood
- #C431WHT - White
- #C431WN - Walnut
- #C431C - Custom



### ▶ ADIRONDACK END TABLE

Size: 19"L x 19"W x 18"H.  
Weight: 21 lbs.

- #C471BLK - Black
- #C471BRN - Brown
- #C471GRN - Green
- #C471DRT - Driftwood
- #C471WHT - White
- #C471WN - Walnut
- #C471C - Custom



### ▶ FOLDING ADIRONDACK

Size: 36"L x 31"W x 34"H.  
Weight: 33 lbs.

- #C430BLK - Black
- #C430BRN - Brown
- #C430GRN - Green
- #C430DRT - Driftwood
- #C430WHT - White
- #C430WN - Walnut



### ▶ CLASSIC ADIRONDACK

Size: 32"L x 30"W x 38"H.  
Weight: 35 lbs.

- #C4261BLK - Black
- #C4261BRN - Brown
- #C4261GRN - Green
- #C4261DRT - Driftwood
- #C4261WHT - White
- #C4261WN - Walnut
- #C4261C - Custom



### ▶ COZY ADIRONDACK

Size: 32"L x 30"W x 32"H.  
Weight: 30 lbs.

- #C428BLK - Black
- #C428BRN - Brown
- #C428GRN - Green
- #C428DRT - Driftwood
- #C428WHT - White
- #C428WN - Walnut
- #C428C - Custom



### ▶ DOUBLE ADIRONDACK

Size: 72"L x 34"W x 38"H.  
Weight: 90 lbs

- #C427BLK - Black
- #C427BRN - Brown
- #C427GRN - Green
- #C427DRT - Driftwood
- #C427WHT - White
- #C427WN - Walnut
- #C427C - Custom



### ▶ ADIRONDACK FOOT STOOL

Size: 16"L x 22"W x 22"H.  
Weight: 19 lbs..

- #C426BLK - Black
- #C426BRN - Brown
- #C426GRN - Green
- #C426DRT - Driftwood
- #C426WHT - White
- #C426WN - Walnut
- #C426C - Custom



### ▶ ADIRONDACK BENCH

Size: 56"L x 36"W x 38"H.  
Weight: 62 lbs.

- #C432BLK - Black
- #C432BRN - Brown
- #C432GRN - Green
- #C432DRT - Driftwood
- #C432WHT - White
- #C432WN - Walnut
- #C432C - Custom



### ▶ HERITAGE END TABLE

Size: 26"L x 24"W x 16"H.  
Weight: 29 lbs.

- #C358BLK - Black
- #C358BRN - Brown
- #C358GRN - Green
- #C358DRT - Driftwood
- #C358WHT - White
- #C358WN - Walnut
- #C358C - Custom



### ▶ 2' HERITAGE CHAIR

Size: 36"L x 25"W x 36"H.  
Weight: 51 lbs.

- #T2452BLK - Black
- #T2452BRN - Brown
- #T2452GRN - Green
- #T2452DRT - Driftwood
- #T2452WHT - White
- #T2452WN - Walnut
- #T2452C - Custom



### ▶ 4' HERITAGE BENCH

Size: 48"L x 25"W x 36"H.  
Weight: 70 lbs.

- #T2454BLK - Black
- #T2454BRN - Brown
- #T2454GRN - Green
- #T2454DRT - Driftwood
- #T2454WHT - White
- #T2454WN - Walnut
- #T2454C - Custom



### ▶ HERITAGE COFFEE TABLE

Size: 48"L x 24"W x 16"H.  
Weight: 56 lbs

- #C359BLK - Black
- #C359BRN - Brown
- #C359GRN - Green
- #C359DRT - Driftwood
- #C359WHT - White
- #C359WN - Walnut
- #C359C - Custom

Color choices for all recycled plastic products

Black	Brown	Green
Driftwood	White	Walnut



### ▶ 6' HERITAGE BENCH

Size: 72"L x 25"W x 36"H.  
Weight: 100 lbs.

- #T245BLK - Black
- #T245BRN - Brown
- #T245GRN - Green
- #T245DRT - Driftwood
- #T245WHT - White
- #T245WN - Walnut
- #T245C - Custom

#T245C - Custom



## THE HERITAGE COLLECTION

### ▶ THE HERITAGE COLLECTION

Create a lounge area that your guests won't want to leave. The Heritage Collection features cozy and practical solutions for any and every outdoor lounge area.



TABLES AND MORE



▶ 6' BARRIER W/ T FEET

Size: 72"L x 14"W x 44"H.  
Weight: 49 lbs.

- #C7006BLK - Black
- #C7006BRN - Brown
- #C7006GRN - Green
- #C7006DRT - Driftwood
- #C7006WHT - White
- #C7006WN - Walnut
- #C7006C - Custom



▶ SYDNEY 48" DECK BOX

Gas shocks now included on each unit so lid doesn't slam when you shut it  
Size: 48"L x 18"W x 18"H.  
Weight: 75 lbs.

- #C3954BBLK - Black
- #C3954BBRN - Brown
- #C3954BGRN - Green
- #C3954BDRT - Driftwood
- #C3954BWHT - White
- #C3954BWN - Walnut
- #C3954BC - Custom



▶ PLANTER BOXES

Our "never rot" planter boxes are perfect for outside your clubhouse, next to the tennis courts, or anywhere else you can think of at your facility! Made from recycled plastic, these boxes come in small and large sizes and are offered in all six of our recycled plastic colors!

Small Planter Boxes  
21.5"l X 5"w X 3.5"h (7 lbs)

- #C523SBLK - Black
- #C523SBRN - Brown
- #C523SGRN - Green
- #C523SDRT - Driftwood
- #C523SWHT - White
- #C523SWN - Walnut
- #C523SC - Custom

Large Planter Boxes  
21.5"l X 5"w X 5.5"h (10 lbs)

- #C523LBLK - Black
- #C523LBRN - Brown
- #C523LGRN - Green
- #C523LDRT - Driftwood
- #C523LWHT - White
- #C523LWN - Walnut
- #C523LC - Custom



▶ HEXAGONAL PICNIC TABLE

Size: 76"L x 76"W x 32"H.  
Weight: 226 lbs. ADA option available.

- #C3559BLK - Black
- #C3559BRN - Brown
- #C3559GRN - Green
- #C3559DRT - Driftwood
- #C3559WHT - White
- #C3559WN - Walnut
- #C3559C - Custom

Color choices for all recycled plastic products

Black	Brown	Green
Driftwood	White	Walnut



▶ 6' RECTANGULAR PICNIC TABLE

Size: 72"L x 50"W x 36"H.  
Weight: 215 lbs. ADA option available.

- #C3506BLK - Black
- #C3506BRN - Brown
- #C3506GRN - Green
- #C3506DRT - Driftwood
- #C3506WHT - White
- #C3506WN - Walnut
- #C3506C - Custom

COURSE COLLECTIONS

Call for quotes and custom options

▶ CONTEMPORARY COLLECTION

Modern, simple, and maintenance free. Our Contemporary Collection of recycled plastic products features no paneling, which means they look even better with your custom logo. Even without it, this new and sleek style looks great in any setting.



▶ NEW ENGLAND COLLECTION

The New England Collection, the timeless paneling style for golf courses everywhere. With squared paneling and sleek trim options, the New England Collection of recycled plastic furniture brings a timeless and professional look to your facility's tee boxes and the areas around your clubhouse.



▶ CONTOUR COLLECTION

Create the elegant look you've always wanted at your course with the Contour Collection of recycled plastic furnishings. Featuring rounded arches and paneling to give your course an elegant and refined look, at a reasonable price. The Contour Collection will keep your course looking its best year after year.



Chat with specialists @ [www.wittekgolf.com](http://www.wittekgolf.com)



## FOR THE POOL



### ▶ SINGLE TOWEL CENTER

Styled after our square trash receptacles, these are perfect for the pool, clubhouse or the tennis area at your facility! Featuring a built in shelf for clean towel storage and a clean looking receptacle for your guests' dirty ones!

Size: 38½" L x 20" D x 44½" H.

- #405600 – Black
- #405601 – Brown
- #405602 – Green
- #405603 – Driftwood
- #405604 – White
- #405605 – Walnut
- #405606 – Custom



### ▶ DOUBLE TOWEL CENTER

Styled after our square trash receptacles, these are perfect for the pool, clubhouse or the tennis area at your facility! Featuring built in shelves on both sides for clean towel storage and a clean looking receptacle in the middle for your guests' dirty ones!

Size: 58½" L x 20" D x 44½" H.

- #405607 – Black
- #405608 – Brown
- #405609 – Green
- #405610 – Driftwood
- #405611 – White
- #405612 – Walnut
- #405613 – Custom



### ▶ SINGLE TOWEL STATION

Made from recycled plastic and available in all of our color options. The Single Towel Station features one compartment with two shelves for towel storage, and a 22 gallon enclosure to deposit used towels into. Perfect for the locker room or pool!

Size: 26" L x 23" D x 70" H.

- #405484 – Black
- #405485 – Brown
- #405486 – Green
- #405487 – Driftwood
- #405490 – White
- #405488 – Walnut
- #405489 – Custom



### ▶ DOUBLE TOWEL STATION

Double your towel storage capacity, in a durable and maintenance free way! Featuring a 22 gallon enclosure for used towels and a two shelf compartment on each side for fresh towels.

Size: 44" L x 23" D x 70" H.

- #405490 – Black
- #405491 – Brown
- #405492 – Green
- #405493 – Driftwood
- #405496 – White
- #405494 – Walnut
- #405495 – Custom



### ▶ CUSTOM AMENITIES CABINETS

Whatever size or configuration you need, we can make it! Made completely from recycled plastic lumber in-house in the U.S.A. We can customize whatever you need for your course, pool and lounge area. Give us a call and let us know how we can help make your facility stand out!



Color choices for all recycled plastic products

Black	Brown	Green
Driftwood	White	Walnut



## SONOMA DINING COLLECTION

### ▶ SONOMA DINING COLLECTION

Designed from the classic English style bench table, the Sonoma Dining Collection is made from recycled plastic making both extremely durable and maintenance free!



### ▶ SONOMA DINING TABLE

Size: 64" L x 38" W x 30" H.  
Weight: 121 lbs.

- #C376BLK - Black
- #C376BRN - Brown
- #C376GRN - Green
- #C376DRT - Driftwood
- #C376WHT - White
- #C376WN - Walnut
- #C376C - Custom

### ▶ SONOMA BENCH

Size: 53" L x 15" W x 17" H.  
Weight: 35 lbs.

- #C377BLK - Black
- #C377BRN - Brown
- #C377GRN - Green
- #C377DRT - Driftwood
- #C377WHT - White
- #C377WN - Walnut
- #C377C - Custom

Color choices for all recycled plastic products

Black	Brown	Green
Driftwood	White	Walnut



### ▶ STACKABLE LOUNGE CHAIRS

Size: 77" L x 22" W x 15" H.  
Weight: 47 lbs.

- #LC844BLK - Black
- #LC844BRN - Brown
- #LC844RN - Green
- #LC844DRT - Driftwood
- #LC844WHT - White
- #LC844WN - Walnut
- #LC844C - Custom



### ▶ LIFEGUARD CHAIR

Size: 41" L x 30" W x 60" H.  
Weight: 111 lbs.

- Security box included.
- #C406BLK - Black
  - #C406BRN - Brown
  - #C406RN - Green
  - #C406DRT - Driftwood
  - #C406WHT - White
  - #C406WN - Walnut
  - #C406C - Custom

Reorder easily @ [www.wittekgolf.com](http://www.wittekgolf.com)



# THE CAFÉ LOUNGE COLLECTION



**▶ CAFÉ SOFA**  
 Size: 36"L x 87"W x 35"H.  
 Weight: 98 lbs. includes cushions  
**#LCR813BLK** - Black  
**#LCR318BRN** - Brown  
**#LCR318GRN** - Green  
**#LCR318DRT** - Driftwood  
**#LCR318WHT** - White  
**#LCR318WN** - Walnut  
**#LCR318C** - Custom

When you order a piece of furniture, the cushions are included in the prices shown above. When ordering, simply use the part number #BACKCUSHION-CLR and #BOTTOMCUSHION-CLR and swap out "CLR" with the numerical code for the color below!

5402	5408	5439
5446	5476	5488
57003		



**▶ CAFÉ ARM CHAIR**  
 Size: 36"L x 29"W x 35"H.  
 Weight: 30 lbs. includes cushions  
**#LC813BLK** - Black  
**#LC318BRN** - Brown  
**#LC318GRN** - Green  
**#LC318DRT** - Driftwood  
**#LC318WHT** - White  
**#LC318WN** - Walnut  
**#LC318C** - Custom



**▶ CAFÉ LOVE SEAT**  
 Size: 36"L x 58"W x 35"H.  
 Weight: 74 lbs. includes cushions  
**#C813BLK** - Black  
**#C318BRN** - Brown  
**#C318GRN** - Green  
**#C318DRT** - Driftwood  
**#C318WHT** - White  
**#C318WN** - Walnut  
**#C318C** - Custom

Color choices for all recycled plastic products

Black	Brown
Driftwood	Green
White	Walnut



**▶ CAFÉ OTTOMAN**  
 Size: 26"L x 24"W x 14"H.  
 Weight: 21 lbs. includes cushions  
**#LC807BLK** - Black  
**#LC807BRN** - Brown  
**#LC807GRN** - Green  
**#LC807DRT** - Driftwood  
**#LC807WHT** - White  
**#CLC807WN** - Walnut  
**#LC807C** - Custom



**▶ CAFÉ END TABLE**  
 Size: 27"L x 24"W x 16"H.  
 Weight: 21 lbs.  
**#LC813BLK** - Black  
**#LC318BRN** - Brown  
**#LC318GRN** - Green  
**#LC318DRT** - Driftwood  
**#LC318WHT** - White  
**#LC318WN** - Walnut  
**#LC318C** - Custom



**▶ CAFÉ COFFEE TABLE**  
 Size: 38"L x 26"W x 16"H.  
 Weight: 51 lbs.  
**#CT812BLK** - Black  
**#CT812BRN** - Brown  
**#CT812GRN** - Green  
**#CT812DRT** - Driftwood  
**#CT812WHT** - White  
**#CT812WN** - Walnut  
**#CT812C** - Custom

Use your terms @ [www.wittekgolf.com](http://www.wittekgolf.com)



**FIRE PITS**  

▶ **RECYCLED PLASTIC FIRE PIT**

Hand crafted from recycled plastic lumber, this unit fits a 20 lb propane tank (not included) featuring a locking door. With a control panel and glass wind guards on each unit, it has never been easier to create a safe and comfortable experience for your guests. Propane tank required but not included.

Size: 47"L x 35"W x 27"H.

Weight: 185 lbs.

- #C600BLK - Black
- #C600BRN - Brown
- #C600GRN - Green
- #C600DRT - Driftwood
- #C600WN - Walnut
- #C600C - Custom



Color choices for all recycled plastic products

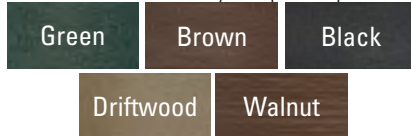

▶ **TABLE TOP FIRE KIT**

This innovative table top fire pit will be the star of your outdoor area! The Intrigue Table Top Outdoor Lantern is designed to fit on virtually any dining or pub table with an umbrella hole 1.4-4". Easy and quick to install. Propane tank required but not included.

#INT-EQ



**UMBRELLAS**



▶ **FRANKFORD MONTEREY 7.5' UMBRELLA**

- Opening system: Pulley
- Pole: Black aluminum
- Vent on top
- Box Dimensions 69" x 9" x 9"
- Weight 20 lbs.
- #75FMUMB-CLR



▶ **FRANKFORD MONTEREY 9' UMBRELLA**

- Opening system: Pulley
- Pole: Black aluminum
- Vent on top
- Box Dimensions 79" x 9" x 9"
- Weight 23 lbs.
- #9FMUMB-CLR



▶ **FRANKFORD AVALON 6.5' UMBRELLA**

- Does not have vent
- Pole: Silver aluminum
- Trim color: White
- Box Dimensions 59" x 9" x 9"
- Weight 13 lbs.
- #65FAUMB-CLR



▶ **FRANKFORD CATALINA 7.5' UMBRELLA**

- Opening system: Pop-up w/ no tilt
- Does not have vent.
- Pole: Black aluminum
- Box Dimensions 59" x 9" x 9"
- Weight 15 lbs.
- ##FC75UMB-CLR

To order, simply add the 3 letter code shown on your color of choice to the part number of any umbrella!

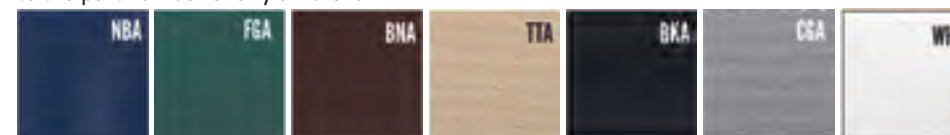



# TEE CONSOLES

It's easy to customize the perfect tee console for your course. Simply follow steps 1 through 4. Pick your stand. Then, configure it with the exact options you want for your tee boxes.

## 1 PICK A STAND

**Permanent Mounting Post**  
2 3/8" Diameter  
#36248ST

**Junior Tee Console**  
Base 19" W  
#36200ST

**Tradition™ Tee Console**  
Base 19" W  
#36230ST

## 2 ADD A BALL WASHER



**Premier Ball Washer**  
Single Ball/Plunger-style  
Capacity 3.6 L

Green	■	#1450ST
Black	■	#1470ST
Red	■	#1425ST



**Medalist Ball Washer**  
Single Ball/Plunger-style  
Capacity 1.6 L

Green	■	#1550ST
Black	■	#1570ST
Red	■	#1525ST



**Classic Ball Washer**  
Four Ball/Crank-style  
Capacity 1.8 L

Green	■	#1350ST
Black	■	#1370ST
Red	■	#1325ST

## 3 ADD TRASH RECEPTACLES

### Litter Mate

- New thicker, stronger shell with easy grip handles molded into side, accented with tough, molded black lid.
- Three lid options – solid, trash or can opening
- Mounts to any 2 3/8" OD (6 cm.) post.
- Includes hardware and trash opening lids.
- 9-gallon (34 L.) capacity per unit
- 15" W x 12" D x 21" H



	Single (Can)	Single (Solid)	Single (Trash)	Double (Trash/Can)
Green	■ #12864ST	#12863ST	#12862ST	#12960ST
Black	■ #12894ST	#12893ST	#12892ST	#12990ST
Red	■ #12864ST	#12843ST	#12842ST	#12940ST



**9-Gallon (34 L.) Litter Caddy - with Spike**

Green	■	#13700ST
Black	■	#13195ST
Red	■	#13150ST

## 4 ADD SPIKE BRUSHES

#14252ST Replacement Brush Gray

#36156BST Console Spike Kleener  
Black w/ Bracket/ Gray Brush

# CONSOLE KITS & TOWELS



47"

### TRADITION™ TEE CONSOLE KIT 1

- Includes Tradition™ Console Stand (Black) and your choice of a Premier™ or Medalist™ Ball Washer.

	Premier Tee Kit 1	Medalist Tee Kit 1
Green	■ #39150ST	#39250ST
Black	■ #39170ST	#39270ST
Red	■ #39125ST	#39225ST



47"

### TRADITION™ TEE CONSOLE KIT 2

- Includes Tradition™ Console Stand (Black), your choice of a Premier™ or Medalist™ Ball Washer, plus matching single Litter Mate™ unit.

	Premier Tee Kit 2	Medalist Tee Kit 2
Green	■ #39350ST	#39450ST
Black	■ #39370ST	#39470ST
Red	■ #39325ST	#39425ST



47"

### TRADITION™ TEE CONSOLE KIT 3

- Includes Tradition™ Console Stand (Black), your choice of a Premier™ or Medalist™ Ball Washer, plus matching double Litter Mate™ unit.

	Premier Tee Kit 3	Medalist Tee Kit 3
Green	■ #39550ST	#39650ST
Black	■ #39570ST	#39670ST
Red	■ #39525ST	#39625ST

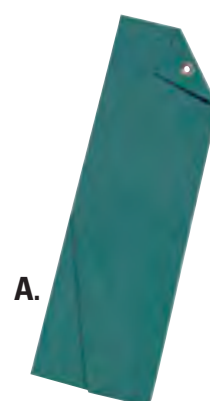

**A. GREEN WASHABLE TEE TOWELS**  
Absorbent and reusable.  
200 per case.  
Size: 21"H x 7"W duo-fold.  
#4970ST

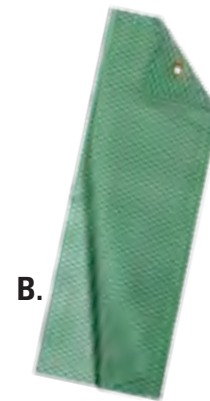

**B. GREEN & WHITE ECONOMY TEE TOWELS**  
Stay stocked, even on tight budgets.  
200 per case.  
Size: 21"H x 7"W duo-fold.  
#4969ST

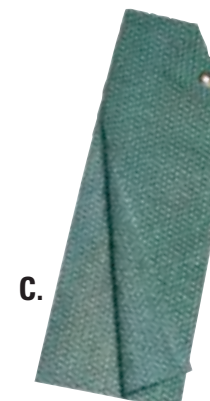

**C. GREEN & WHITE DISPOSABLE TOWELS**  
Reinforced with nylon threads and tough metal eyelet.  
200 per case.  
Size: 21"H x 7"W tri-fold.  
#4965ST



**D. LARGE COTTON TOWELS**  
Priced/Dz.  
Size: 18"H x 6"W tri-fold.  
#4100ST - White  
#4200ST - Green



**E. EMBROIDERED TOWELS**  
Priced/Dz.  
Size: 18"H x 6"W tri-fold.  
#405185-E - White  
#405186-E - Green



▶ TEE TOWELS

The perfect tee towel for every occasion is just one call away! Great for attaching to ball washers, placing in golf carts, tournament give aways and selling in the shop! Available in either our high quality, 100% cotton velour towel or a microfiber waffle knit texture, both sold with or without a custom embroidered logo and are available in a variety of fold and grommet options.

**100% cotton velour**  
multiple fold / grommet options  
16" W x 26" L

Color/Style	(A) Tri-Fold Short	(B) Tri-Fold Long	(C) Corner Fold	(D) C-Fold
Black Cotton	#TTC-BLK-TS	#TTC-BLK-TL	#TTC-BLK-CRN	#TTC-BLK-C
Navy Cotton	#TTC-N-TS	#TTC-N-TL	#TTC-N-CRN	#TTC-N-C
Green Cotton	#TTC-G-TS	#TTC-G-TL	#TTC-G-CRN	#TTC-G-C
Royal Cotton	#TTC-B-TS	#TTC-B-TL	#TTC-B-CRN	#TTC-B-C
Grey Cotton	#TTC-GRY-TS	#TTC-GRY-TL	#TTC-GRY-CRN	#TTC-GRY-C
White Cotton	#TTC-W-TS	#TTC-W-TL	#TTC-W-CRN	#TTC-W-C

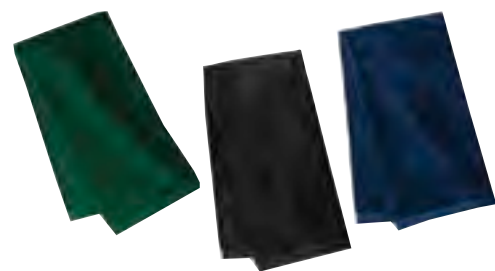

**80/20 poly/nylon microfiber**  
waffle texture  
15.25" W x 24.25" L

Color/Style	(A) Tri-Fold Short	(B) Tri-Fold Long	(C) Corner Fold	(D) C-Fold
Black Micro	#TTM-BLK-TS	#TTM-BLK-TL	#TTM-BLK-CRN	#TTM-BLK-C
Navy Micro	#TTM-N-TS	#TTM-N-TL	#TTM-N-CRN	#TTM-N-C
Green Micro	#TTM-G-TS	#TTM-G-TL	#TTM-G-CRN	#TTM-G-C
Royal Micro	#TTM-B-TS	#TTM-B-TL	#TTM-B-CRN	#TTM-B-C
Grey Micro	#TTM-GRY-TS	#TTM-GRY-TL	#TTM-GRY-CRN	#TTM-GRY-C
White Cotton	#TTM-W-TS	#TTM-W-TL	#TTM-W-CRN	#TTM-W-C



Do you want embroidered towels with your tournament, outing or course's logo on them? Custom towels make for great giveaways and even better items to sell in your shop. Give us a call and let us make a package for you!

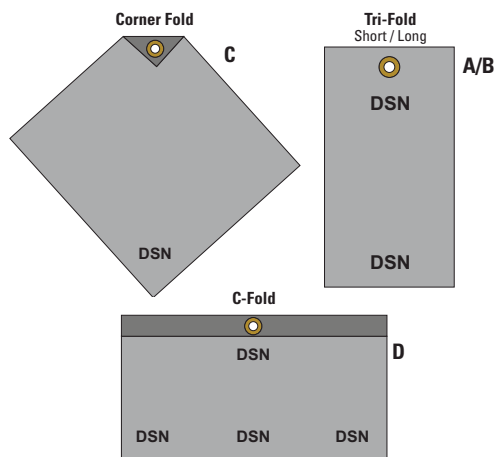

Add "-E" to any of the part numbers above to easily order these embroidered for:

Add "-E" to any of the part numbers above to easily order these embroidered for:

▶ HAND SANITIZER STATION

Made from recycled plastic, these enclosures are perfect for any other high traffic areas at your facility! This is made with a movable base or an in-ground post mounting option. Station does not include hand sanitizer.

Size: 48"L x 18"W x 18"H. Weight: 75 lbs.



- #406561-P – Green – Inground Post
- #406562-P – Brown – Inground Post
- #406563-P – Black – Inground Post
- #406564-P – Driftwood – Inground Post
- #406562WN-P – Walnut – Inground Post

- #405651-B - Green Portable Base
- #405652-B - Brown Portable Base
- #405653-B - Black Portable Base
- #405654-B - Driftwood Portable Base
- #405652WN-B - Walnut Portable Base



Color choices for all recycled plastic products

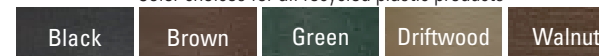

▶ DISPOSABLE STEERING WHEEL COVER

- Fully elasticized.
- Slip resistant, plastic design.
- Packed 500 per case.

#650WC



▶ CART DIVIDER

- Utilize your cart's full capacity in under 2 minutes!
- Crystal clear, UV resistant construction.
- Flexible & lightweight, durable and cold crack resistant.
- Anti-bacterial and easy to clean with a bleach and water mixture.
- Bungee cords are included, 16 gauge vinyl piece separates passengers.
- These cart dividers currently do not fit carts with GPS units mounted in the front/EZ Go RXV Elite carts.
- Drilling holes in your cart is required for installation of these units. Small style is 32"H x 32"W, designed to fit all Club Car models. Large style is 35"H x 32"W designed to fit all EZ Go and Yamaha models.

#500200 - Club Car Divider

#500201 - EZ Go/Yamaha Divider

▶ COVID SIGNS

These aluminum signs with red vinyl decals used for the messages are made in-house in the U.S.A. These signs withstand the test of time!



#500108 12" x 18"



#500100 12" x 12"



#500101 12" x 12"



#500102 12" x 12"



#500103 12" x 12"



#500104 12" x 12"



#500105 12" x 12"



#500106 12" x 12"



#500107 12" x 12"





▶ **HAND SANITIZER**

- Non-sterile, hand sanitizer solution.
- Liquid alcohol antiseptic.
- 80% topical solution.

#269001G – Pack of 4, 1 Gallon Containers

#269001Q – Pack of 6, 1 Quart Containers



▶ **HAND SOAP**

- Contains lanolin.
- Fresh scent.
- Mild to skin.
- Ideal for work or home.

#268939 – Pack of 6, ½ Gallon Containers

#512924 – Pack of 4, 1 Gallon Containers



▶ **CONCENTRATED ALL PURPOSE CLEANER**

- Removes a variety of soils from any washable hard surface.
- Leaves a fresh pleasant scent after cleansing.
- Biodegradable, rinse-free formula.

#513066 – Pack of 4, 1 Gallon Containers

#513025 – Pack of 1, 5 Quart Containers



▶ **ALL PURPOSE CLEANER W/ BLEACH**

- Removes a variety of soils from any washable hard surface.
- Contains bleach.

#513066A – Pack of 4, 1 Gallon Containers

▶ **MARKING WAND**

Compatible with any brand of marking paint.

#405917



▶ **RUST-OLEUM® MARKING PAINT**

More feet per can means fewer cans of paint to buy, every foot of Rust-Oleum® marking paint you lay down is more money saved. Available in 12 vivid colors for temporary markings on grass, gravel, concrete or asphalt. Twelve (12) 17 oz. cans per case.



#405900 - White	#405904 - Safety Green	#405909 - Fluorescent Orange
#405901 - Bright Yellow	#405906 - Caution Yellow	#405910 - Fluorescent Green
#405902 - Safety Red	#405907 - Caution Blue	#405911 - Fluorescent Red/Orange
#405903 - Alert Orange	#405908 - Fluorescent Pink	#405912 - Black

Buy 12 or More & Get FREE Freight

**HOLE CUTTERS & ACCESSORIES**



▶ **HOLE CUTTER GUIDE**

Made from laminated plastic this hole cutter guide combines precision with durability, for the perfect cut every time! Available in green & white, it is virtually indestructible!

#G500 - Hole Cutter Guide



▶ **CUP COVER**

Protect your cups from weather and debris! Made in-house from recycled plastic lumber

#G501 - Cup Cover



▶ **HOLE CUTTER DEPTH GAUGE**

Ensures consistent, accurate cuts w/ Magnum™ or Pro II Hole Cutters.

#28600ST - Depth Gage



▶ **SHARPENER**

- Works with scalloped or straight cutter styles – inside or outside.
- Keep shells sharp for easier cuts and precision cut hole edges.

#28400ST

▶ **PRECISION HOLE CUTTER**

This is the professional's hole cutter, with features including:

- Utilizing a built in slide hammer (with noise damper) for easy and accurate cutting.
- Built in level on the handle for vertical cutting.
- Two cutting depth gauges for regulation and putting cup depths, making the depth right every time.
- Quick blade change over.
- Padded handles for comfort.
- Two blade choices for either sand or clay.
- 4½" L x 4½" W x 36" H
- Weight 17 lbs.

The precision cutter has proven to reduce cup changing time by approximately 30 minutes per day on a typical eighteen hole course.



▶ **INSIDE SHARP**

#G490 - Hole Cutter For Sand Greens  
#G491 - Replacement Blade - Sand (Inside sharpened)

▶ **OUTSIDE SHARP**

#G490C - Hole Cutter For Clay Greens  
#G491C - Replacement Blade - Clay (Outside sharpened)



Foam Padded Chest Handles

Level

Two Depth Indicators

Slide Hammer

Sound Absorbing Cushion

36"

4½"



## HOLE CUTTERS &amp; SHELLS

▶ **PRO II FOOT EJECTOR HOLE CUTTER**

- Simple, economical and ready to cut.
  - Hot-rolled tubing and carbon steel shaft.
  - Adjustable depth collar with foot ejector.
- #28700ST** - Cutter, Straight, Sharpened Inside  
**#28800ST** - Cutter, Scalloped, Sharpened Inside  
**#28801ST** - Cutter, Scalloped, Sharpened outside  
**#28775ST** - 6" Cutter, Straight, Sharpened Inside  
**#28785ST** - 8" Cutter, Straight, Sharpened Inside

▶ **TURFMASTER® HOLE CUTTER**

- Razor-sharp outside sharpened blades prevent soil compaction and minimize impact on the putting surfaces and fragile root systems.
  - Use rubber mallet to drive in the blade halves.
  - 20" H ( 10.65 lbs )
- #28000ST**- Turf Master Hole Cutter .  
**#28002ST** - Replacement Blade (2 per unit)

▶ **MAGNUM® LEVER ACTION HOLE CUTTER**

- Field-tested and proven in all soils... with flying colors.
  - Smooth lever action.
  - Full selection of cutter shells to match your conditions.  
4 1/4" Diameter
- #28960ST** - Cutter, Straight, Sharpened Inside  
**#28970ST** - Cutter, Scalloped, Sharpened Inside  
**#28980ST** - Cutter, Scalloped, Sharpened outside

▶ **HOLEMASTER® HOLE CUTTER**

- Cutting into hard soil greens?  
Make it cleaner and easier.
- Durable, outside sharpened case-hardened blades reinforced with webs and backing plates.
  - Side pins lock in shell for easy extraction, rubber mallet drives blade halves home.
- 4 1/4" Diameter
- #28350ST** - Hole Master Hole Cutter  
**#28352ST** - Replacement Blade (2 per unit)

▶ **REPLACEMENT SHELLS**

Fits Magnum, Pro II & Par Aide Hole Cutters  
Standard Golf recommends inside sharpened cutting blades primarily for sand greens. They pack the sand tighter and hold it more firmly in place.

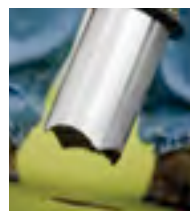

Trouble disengaging plugs? Spend just a few minutes sanding the inside of the blade with emery paper. You'll be amazed at how much easier it is to unplug.

- #28927ST** - Straight, Sharpened Inside  
**#28952ST** - Scalloped, Sharpened Inside  
**#28953ST** - Scalloped, Sharpened Outside  
**#28990ST** - Scalloped Shell Sharpened Inside For Side Mount Hole Cutters
- #28777ST**- 6" Straight, Sharpened Inside  
**#28787ST** - 8" Straight, Sharpened Inside

▶ **CUP HOOK**

- Simple and easy way to remove any style cup.
  - 11 1/2" long
- #33200ST**

▶ **CUP SETTER**

- Set it, step on it and lift it out.
  - Sets cup to USGA-specs - 1" below surface of the green.
  - Flattens and smoothes crowning caused by hole cutters.
  - Minimizes damage to the rims of aluminum cups.
- #30100ST**

## HAND TOOLS

▶ **SOIL PROFILE SAMPLER**

- Quickly pull a clean root zone sample.
- Check roots in fine turf areas.
- Steel construction. Zinc-plated, case-hardened blade.
- 4"W x 8"H x 3/4"D samples.

**#29400ST**

▶ **8" PRO II HOLE CUTTER / REPAIR TOOL**

- Made for installing 8" special event cups, and perfect for quick and easy turf repairs.
- Expeller assembly makes ejecting 8" plugs a breeze, minimizing frustration and wasted time.
- Replaceable 8" inside sharpened shell also available.
- 8" Diameter.

**#28785ST** - Hole Cutter Straight Inside

▶ **TURF DOCTOR**

- Invisible sod replacement!
  - Finish patch areas without leaving holes or gaps (i.e., irrigation repair).
  - Razor-sharp blades
- (4) secure 9" square-cut, wedge-shaped sod blocks that fit and butt perfectly.

**#29200ST**

▶ **HAND AERIFIER**

- Choose solid or hollow tines;
- 2 1/4" penetration.
- Rugged steel construction. Core collector is built right into the base.
- 3" x 3/8" replaceable tines on 2" centers.

**#29808ST** - Body Assembly Only  
**#29803ST** - Hollow Tine Base Assembly  
**#29805ST** - Solid Tine Base Assembly

▶ **GREENSKEEPER BALL MARK REPAIR TOOL**

- Great time-saving, labor-saving tool for quick, near-flawless repairs on greens.
- 36" handle makes repairs fast and easy.
- Meticulously lifts dirt/grass into place in one motion.

**#27200ST**

▶ **HEXAGON TURF REPAIR TOOL**

- Innovative plug design for easy sod/soil removal and seamless replacement.
- Six-sided plugs pull wedges that are 7"W x 4"D.

**#29225ST**



## TRIMMERS

▶ **TURBOTRIM HEAD TRIMMER**

The only trimmer with a forward and reverse drive ratchet mechanism

- Super heavy-duty steel construction w/ powder-coated finish
- Comfortable rubber handle grips
- Interchangeable cutting blades to match your sprinkler model

#TTRC-007 - 7" Turbotrim Head Trimmer Cutting Blade

#TTRC-008 - 8" Turbotrim Head Trimmer Cutting Blade

#TTRC-100 - Turbotrim Tool w/out Cutting Blade

▶ **"POWERHEAD" SPRINKLER HEAD TRIMMER**

The "Powerhead" device has to be tried to see how well it works. Simply attaching to the base of all major brand grass trimmer machines, it trims sprinkler heads, irrigation boxes and yardage markers in a flash. With no more strings to contend with, the Powerhead will cut hours off your trimming. Please indicate make and model of your trimmer machine. This product comes in four sizes.

#400770 - 6" (Toro 630/730/760)

#400771 - 6½" (Hunter/Legacy 520)

#400772 - 7½" (Toro 650 / 655 / 670 / 780)

#400773 - 10" (Toro 690/Rainbird, 91DR Rainbird, 91DS/10" Valve Box)

▶ **TAS HEAD TRIMMER**

Made from heavy duty steel, these head trimmers are fast and efficient. Ideal for sprinkler heads, control valve covers, etc. Sizes span from 3 3/4" to 10" diameters and are designed to fit all major brands of trimmer machines.

\* If installing on Echo equipment, when placing your order please remember that a steel spacer is needed.

\* Brush cutter blade adapter kit needed, not included.

#400760 - 3¾" Diameter

#400761 - 5½" Diameter

#400762 - 7" Diameter

#400763 - 7½" Diameter

#400764 - 8" Diameter

#400765 - 8½" Diameter

#400766 - 10" Diameter

## RAKES &amp; GAUGES

▶ **ROLLER SQUEEGEE**

High strength double-ribbed aluminum channel. Corrosion resistant material. Durable closed cell foam rubber roller and completely watertight assembly. Roller hub made of industrial grade bearing material. Stainless steel axle. Solid reinforced end bracket. 57½" handle.

#71324ST - 24"

#71336ST - 36"

#71348ST - 48"

▶ **LEVELAWN**

- Distributes application materials.
- Removes stones from soil, breaks up small clods of sand or loam.
- Smooths soil for easy planting.

#29300ST - 30" Levelawn

30"L x 30" W (9.65 lbs.)

#29375ST - 36" Levelawn

31"L x 30" W (9.8 lbs.)

▶ **LEAF RAKE**

A basic but essential rake, with a heavy duty 19" wood handle. Perfect for any and every maintenance project.

67"L x 23½"H (2.4 lbs.).

#400701 - 19"

▶ **SPRING BACK RAKE**

AA heavier duty rake for your grounds crew's toughest projects. A longer, 24" wood handle to make cleanup a breeze.

63"L x 20¼"H (1.9 lbs.).

#400700 - 24"

▶ **DEBRIS RAKE**

This well known multi-purpose maintenance rake comprises tempered spring steel wire teeth mounted on a durable plastic head, handle is 60" heavy-duty fiberglass. The rake is ideal for removing debris from bunkers particularly pine needles, and final finishing of bunker sand

21"L x 60"H (7 lbs.).

#400233

▶ **GROOMER GAGE**

This is a precision measuring instrument for accurately setting the desired grooming depth of groomer or verticutting units.

24"L (2 lbs.)

#400807

▶ **ACCU-GAGE II**

This is similar to ACCU-GAGE although it is altered to be used in the field or while units are still attached to mowers.

24"L (2 lbs.)

#400806

▶ **ACCU-GAGE**

This precision tool is used to set accurate height-of-cut adjustments on greensmowers. Incorporating a dial indicator with adjusting bar apparatus highly accurate measurements can be made at the cutting edge of the bed knife. Measurements read as .001" or 01mm, fits all greensmowers. ( 1.5 - 2 lbs.)

#400800 - 18" Bar

#400801 - 18" Bar Hands Free

#400802 - 18" Bar Digital Version

#400803 - 24" Bar



## SOIL SURFACTANTS APPLICATORS & IRRIGATION TOOLS

### ▶ PELLETPRO™ HEAVY-DUTY SURFACTANT APPLICATOR

Our heavy-duty surfactant applicator, high-flow valve and Precision™ Cloudburst™ nozzle combo comprises the finest wetting agent gun available. PelletPro™ accepts all wetting agent tablets and provides a high volume, yet soft spray for watering or applying surfactants to tight, hydrophobic soils.

- 35+ GPM to get the job done faster!
- Ultra Heavy-Duty construction: brass fittings, aircraft aluminum, stainless steel, precision engineered glass.
- Pellet rotation (1 RPS) evenly dissolves/applies tablets.
- Patented Cloudburst™ nozzle delivers large droplets in an outstanding fan pattern.

#A-PPWA50K-UH - Pellet Pro

#A-PPB-UH - Bowl Only

#A-PPBG-UH - Gasket Only

#400543 - ABS High-Flow 3/4" Valve Full Flow, Oversized Handle



### ▶ POLYPROPYLENE MEASURING PITCHERS

Made of food grade polypropylene, these pitchers are resistant to most agricultural chemicals. Thick walled and easy to handle for excellent controlled pouring. Measurement graduations in US fluid oz. and mils.



#406640	8 oz. Pitcher
#406641	16 oz. Pitcher
#406642	32 oz. Pitcher
#406643	64 oz. Pitcher
#406644	128 oz. Pitcher

### ▶ MULTI-PURPOSE TOOL AND KEYS



#A-SKTRB-UH - Super Key XL  
#406631 - Rainbird Easyreach Key  
#406632 - Toro Easyreach Key

### ▶ GULP™ ULTRAMAX SUPER HIGH-CAPACITY WATER REMOVAL SUCTION PUMPS

- Super smooth pumping action.
- High volume capacity.
- Strong aluminum pump shaft.
- Contour grip handle.
- No leak seals.
- Self priming.
- Gulp & Big Gulp has easy push button cleaning system along with included debris filter attachment.

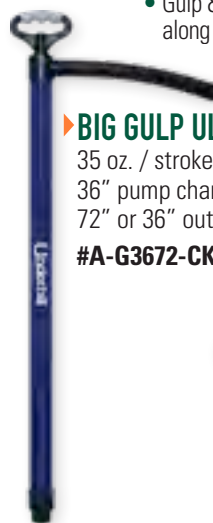

#### ▶ BIG GULP ULTRAMAX

35 oz. / stroke  
36" pump chamber  
72" or 36" outlet hose

#A-G3672-CK-UH



#### ▶ GULP ULTRAMAX

18 oz. / stroke  
14" clear pump chamber  
18" outlet hose

#A-G12-C-UH



#### ▶ GULP SYRINGE ULTRA

12 oz. / stroke  
12" pump chamber

#A-G125-C-UH

## FINALLY THE RIGHT LENGTH HOSE FOR THE RIGHT JOB!

### ▶ SHORTY PRO™

- Ideal for quick green, tee syringing without extra hose to carry around
- Ideal for equipment wash-down
- Rated to 1200 Psi Burst Pressure

#H75-S10-UH	3/4" x 10'
#H75-S20-UH	3/4" x 20'
#H10-S10-UH	1" x 10'
#H10-S20-UH	1" x 20'



### ▶ ULTRA MAX GREEN HOSE

Superintendents' favorite for years. This hose offers 800PSI burst strength with 200 PSI WP.

#H75-050G-UH	3/4" x 50'
#H75-075G-UH	3/4" x 75'
#H75-100G-UH	3/4" x 100'
#H10-050G-UH	1" x 50'
#H10-075G-UH	1" x 75'
#H15-100G-UH	1" x 100'



### ▶ ULTRA MAX BLUE HOSE

Super lightweight and super strong. This hose offers 1200 PSI burst strength with 300 PSI WP.

#H75-050B-UH	3/4" x 50'
#H75-075B-UH	3/4" x 75'
#H75-100B-UH	3/4" x 100'
#H10-050B-UH	1" x 50'
#H10-075B-UH	1" x 75'
#H15-100B-UH	1" x 100'



### ▶ ULTRA MAX RED HOSE

This hose is the ultimate choice for long life under heavy use. Made of EPDM synthetic rubber and reinforced with spiral synthetic yarn.

#H75-050R-UH	3/4" x 50'
#H75-075R-UH	3/4" x 75'
#H75-100R-UH	3/4" x 100'
#H10-050R-UH	1" x 50'
#H10-075R-UH	1" x 75'
#H15-100R-UH	1" x 100'



### ▶ ULTRA MAX CLEAR HOSE

Lightweight and durable, this hose offers 600 PSI burst strength with 150 PSI WP.

#H75-050C-UH	3/4" x 50'
#H75-075C-UH	3/4" x 75'
#H75-100C-UH	3/4" x 100'
#H10-050C-UH	1" x 50'
#H10-075C-UH	1" x 75'
#H10-100C-UH	1" x 100'



## HOSES & IRRIGATION NOZZLES

### ▶ PREMIUM HOSE-END NOZZLES & ACCESSORIES

- Multi-pattern sprays - effortless control with hydraulic assist on/off.
- Solid metal internal - no plastic parts to break or wear out.
- Ratchet mechanism prevents over-tightening damage.
- Ultra-durable construction withstands any abuse.
- Fire hose quality nozzle feels great in your hands.
- Beautiful, consistent spray patterns for life.
- Built for 1" and 3/4" flow rates.



#NG-550-DFH-75-UH	Turbo Shift High Flow 3/4" 12-43 GPM
#NG-500-SFH-75-UH	Full Throttle High Flow 3/4" 15-40 GPM
#NG-550-DFH-10-UH	Turbo Shift High Flow 1" 12-43 GPM
#NG-500-SFH-10-UH	Full Throttle High Flow 1" 15-40 GPM

### ▶ DRAINBLASTER™ HIGH PRESSURE DRAIN CLEANING NOZZLE

This unique hose-end, high pressure nozzle guides itself in cleaning out drains, to remove debris with ease. Special feature includes a wire attachment connector for using wire locator to determine drain route. Minimum water pressure: 70 PSI

#DN-75-UH	3/4" Nozzle
#DN-10-UH	1" Nozzle



### ▶ MULTI PURPOSE ADJUSTABLE NOZZLES

Made of durable, high strength plastic, these economical nozzles adjust to a variety of sprays.



#406600	3/4" Multi Purpose Nozzle
#406601	1" Multi Purpose Nozzle
#406602	3/4" Trigger Nozzle

See your invoices/statements @ [www.wittekgolf.com](http://www.wittekgolf.com)



## COURSE MAINTENANCE ACCESSORIES

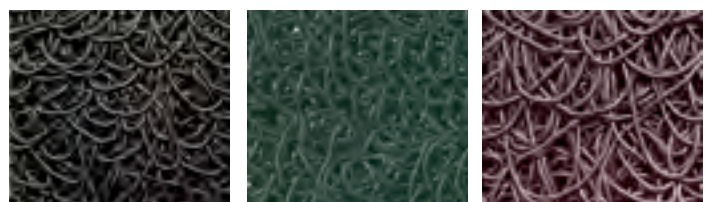

Colors available upon request:



Gray



Sandstone



### ▶ DEW WHIPPING POLE

Fiberglass 2 piece pole with 5/16" single rod taper lock extension.

Sheathed length: 7½ ft. Extended length: 14½ ft. (2.1 lbs.)

#34200ST- Dew Whipping Pole

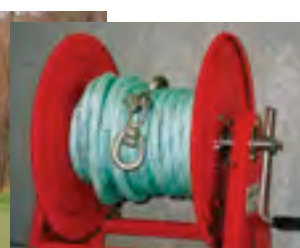

### ▶ FAIRWAY SNAKE

The Fairway Snake is lead weighted and has a heavy duty rope that is specifically designed to drag a fairway. The weighted line breaks up grass clippings, reduces disease pressure, and helps to stand up the turf. It is easily pulled using 2 utility vehicles.

#400215 - 100 ft. (50 lbs.)

#400216 - 150 ft. (75 lbs.)

#400217 - 200 ft. (100 lbs.)

#400220 - Reelcraft Reel (50 lbs.)

### ▶ ADHESIVES

#400584 - PVC Seam Backing Strip, 100 ft. Roll

#400585 - GE 1800 Silicone, 10.1 oz. Tube

#400586 - Pro Fix 240 Seam Adhesive, 1 lb. Bottle

#400587 - Pro Fix 241 Seam Adhesive Accelerator, 6oz. Can



## COURSE MAINTENANCE ACCESSORIES



### ▶ COCO DRAG MAT

A Superintendent's favorite. Made from cocoa fiber and strengthened with a thick plastic backing, this great mat will last many seasons. Absolutely the best mat for protecting your greens when top dressing and filling aerated holes.

#400110 - 4' x 6' (67 lbs.)

#400111 - 5' x 6' (81 lbs.)

#400112 - 6' x 6' (90 lbs.)

### ▶ METAL FLEXIBLE DRAG MAT

These super durable mats are ideal for moving sand and seed. Easy to handle and store. Custom sizes are available.

#400120 - 3' x 5' (27 lbs.)

#400121 - 5' x 5' (45 lbs.)

#400124 - 6' x 7' (73 lbs.)



### ▶ DRAG BRUSH

A long-time classic and favorite among superintendents. It gently and evenly works top dressing material into the green and helps control thatch when used before mowing. Extensions are available for bigger jobs. Doubles the length of the brush. Hinged and weighted to help manage contours and uneven areas.

54 ½"W x 26"H (245 lbs.)

#52000ST - Drag Brush

#52013ST - Replacement 54" Brush Only

27"W x 26"H

#52050ST - Set of Two Extensions

#52063ST - Replacement Brush for Extension

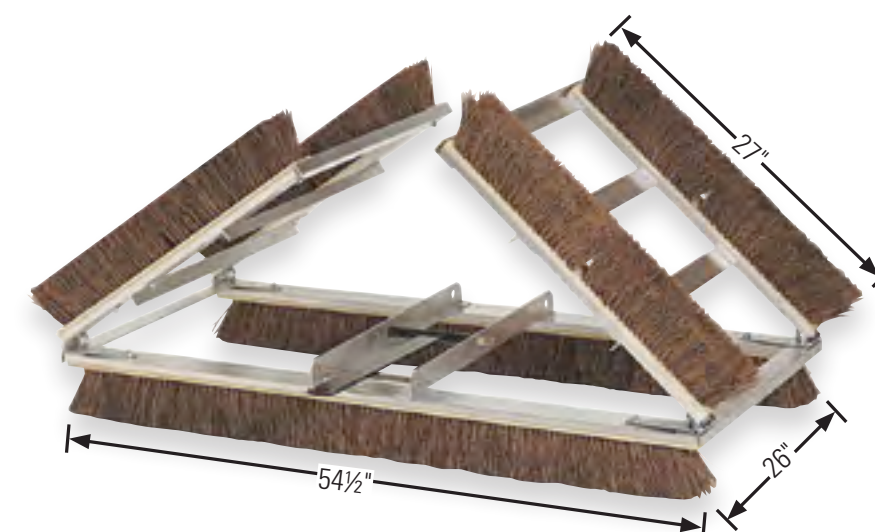



## GOLF CART ACCESSORIES



## ▶ KOOLIT COOLERS

A quality cooler for courses that provide beverages for their guests. Soft sided, leak-proof, insulated cooler bag holds up to a 12 pack of can beverages and ice to keep drinks cold for hours. Lightweight, reusable design folds up to 1" thick for compact storage. Easy snap handle. Size: 8"W x 18"H x 6"D (Full). Weight: .36 lb.

#53375 - "Please Return to Clubhouse"



## ▶ PRO RENTAL CART

- Durable and dependable.
- Virtually maintenance free.
- Turf saving 3" wide wheels.
- Cushioned support fits any size bag.
- Removable handle for easy storage.
- Steel ball bearings.
- Weight: 33 lbs./set of 2.

#54006 - Pro Rental Cart, Wide Wheel

#54005 - Pro Rental Cart, Standard Wheel



## ▶ BUGGY COOLER

Fits any golf cart with a roof top. Attaches in seconds. Holds 18 cans or 12 bottles. The top storage pocket is perfect for sandwiches or snacks. The side pockets store golf balls, tees or cell phones. Includes a hidden drain plug in the bottom of the cooler to drain melted ice. 32"L x 2"W x 14"H Weight: 3 lbs.

#93535 - Buggy Cooler



## ▶ GOLF CART TOWELS

Made of terry cloth Available in beige, black and green. Size 15" x 25" 2.50 lbs. (box) No grommet.

#53360 - Beige

#53361 - Black

#53362 - Green



## ▶ BUGGY COVER 3 X 4

Stay Warm, Dry and Comfortable!

- Designed by PGA Professionals.
- Patented "roll-away" windshield.
- Fits over most rooftop golf carts.
- Folds into convenient nylon carry bag.
- Sets up in seconds with "Jam Cleat" fastening system.
- Made of durable 430 nylon and heavy clear vinyl.
- Size: 58"H x 52"L x 44"W Weight: 10 lbs.

#93523 - Black

#93526 - Forest Green

#93528 - Red

#93529 - Tan

#93533 - Navy Blue

#93540 - Yamaha Drive (specify color)

#93541 - Club Car Precedent (specify color)



#93523



#93528

## TOURNAMENT ACCESSORIES

## ▶ CART ID FLAGS

- Includes clamp so your guests can mark their carts
- ½" stick, 2' long

#401992 - Disabled Player

#401993 - Marshal



Now with NEW improved clip design in 2021!



## ▶ "CLOSEST TO THE PIN" MARKERS

Made from durable ½" laminated plastic, these proximity markers include a 50' tape measure.

#S304CTP



## ▶ LONG DRIVE MARKER

The perfect marker for every tournament at your course! Made from ½" laminated plastic with a spiked base, these markers will outlast standard metal proximity markers at a great price!

#S304LD - Long Drive Marker



## ▶ CART TOPPERS

Finally a tournament solution that actually works! Make sure your guests know which cart is theirs, and that you get them out on the course on time. These cart toppers make it easy to make tournaments run smoothly! Available in Black, Blue, Green, Hot Pink, Orange, Purple, Turquoise, Yellow, Red, Lime, White, Tan.

#94405 - Set of 18 (1A-18A)

#94404 - Set of 36 (1A-18A), (1B-18B)

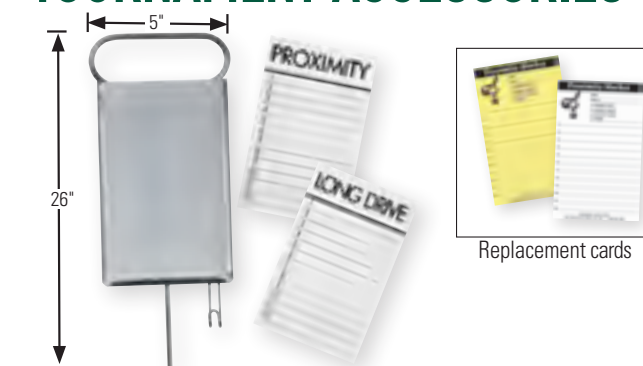

## ▶ PROXIMITY MARKERS

Placed on the tee, fairway or green, these proximity markers can be used to mark hole contests such as "Longest Drive", "Closest to the Pin" and "Longest Putt". Four markers per set. Each set contains: Four markers with pencil holders. Four packs of double-sided cards (25 each) printed with LONG DRIVE on one side and PROXIMITY on the other. Size: 29" x 7½" x 2½". Weight: 6 lbs.

#10700ST - Proximity Marker Set

#10701ST - Replacement Cards (25/per pkg.)

#94406 - Replacement Cards w/Contest Indicator.

5"W x 8"H. (25/per pkg.) Yellow.



## ▶ TEE BOX CONTEST SIGNS

These double sided 12" x 6" laminated plastic signs are perfect for letting your players know what lies on the hole ahead!

#405893 - Closest To The Pin

#405894 - Long Drive

#405895 - Straightest Drive

## ▶ TOURNAMENT STARTER CASE

A must for all tournament organizers.

Perfect for the 1st and 10th tees.

Opens up to feature a bulletin board for posting tee times and rules sheets. Also serves as a central location for tees, pencils, repair tools, etc. Wooden dowel rods act as a paperweight so papers stay organized. Laminated wood grain finish resists scuffs and scrapes. Closes into a convenient storage and carrying case with handle.

4"H x 26¼"W x 17½"D. Weight: 25 lbs.

#68525





PENCILS

▶ **HEX PENCILS** 

Our cedar pencils have a fine grain and a smooth, satiny finish. Traditional 6 sided construction. Available in 8 colors - please specify.



	Black	Blue	Cranberry	Green	Natural	Red	White	Yellow	Length
No Eraser, Plain	#84115	#84118	#84119	#84116	#84120	#84216	#84121	#84316	3 1/2"
No Eraser, Personalized	#84150	#84151	#84152	#84160	#84153	#84170	#84154	#84180	3 1/2"
w/ Eraser, Plain	#84604	#84600	#84605	#84601	#84606	#84602	#84607	#84603	3 7/8"
w/ Eraser, Personalized	#84630	#84626	#84631	#84627	#84632	#84628	#84634	#84629	3 7/8"

**Pencil Custom Imprint Information:** Hex Pencil Imprint Area: 2 1/2" x 1/4". Maximum 30 characters and spaces per line, up to 3 lines of imprint. No Plate Charge. Minimum Order, Personalized: 20 Gross. Imprint Colors: Black, Blue, Gold, Green, Maroon, Purple, Red, Silver, White, Yellow.

▶ **ROUND PENCILS** 

Ideal for imprinting your logo. Featuring soft feel and exceptionally smooth paint coatings. Available in 8 colors - please specify.



	Black	Blue	Cranberry	Green	Natural	Red	White	Yellow	Length
No Eraser, Plain	#84670	#84671	#84672	#84673	#84674	#84675	#84676	#84677	3 1/2"
No Eraser, Personalized	#84680	#84681	#84682	#84683	#84684	#84685	#84686	#84687	3 1/2"
w/ Eraser, Plain	#84640	#84641	#84642	#84643	#84644	#84645	#84646	#84647	3 7/8"
w/ Eraser, Personalized	#84660	#84661	#84662	#84663	#84664	#84665	#84666	#84667	3 7/8"

**Pencil Custom Imprint Information:** Round Pencil Imprint Area: 2 1/2" x 3/4". Logo and 2-3 lines of imprint on Round Pencils Only: Minimum Order, Personalized: 20 Gross. Imprint Colors: Black, Blue, Gold, Green, Maroon, Purple, Red, Silver, White, Yellow

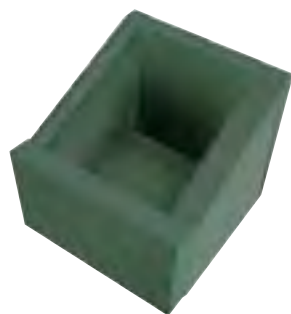

**PENCIL BOX** 

An attractive and durable way to store & display your pencils on the counter! Holds up to 144 pencils. 3"H x 5"W x 6"D (4 lbs.)

- #P300BLK - Black
- #P300BRN - Brown
- #P300GRN - Green
- #P300DRT - Driftwood
- #P300WN - Walnut
- #P300C - Custom

TEES

▶ **BAMBOO TEES**

Are a sustainable and environmentally friendly alternative to plastic golf tees. 10,000 Tees per carton.

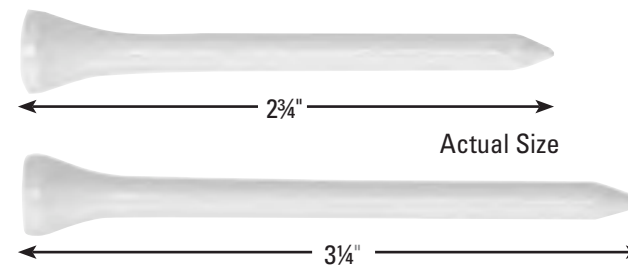

Color	2 3/4"	2 3/4" (per bag)	3 1/4"
White	#92620	#92630	#92603
Natural	#92621	#92631	#92604

▶ **DELUXE TEES**

Feature the proslim shank measuring .171 in diameter. Available in 11 Stock Colors: Mixed, Natural, White.

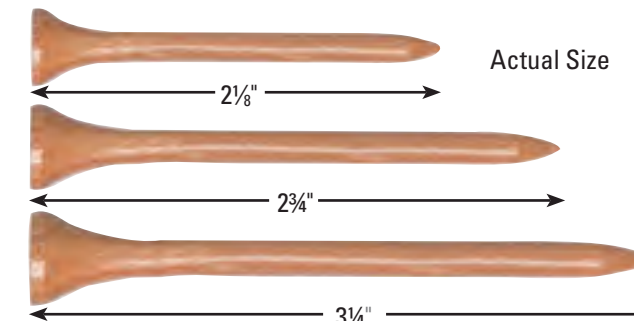

Color	2 1/8" (10M) BULK	2 3/4" (10M) BULK	3 1/4" (7.5M) BULK
White	#92805	#92807	#92810
Natural	#92803	#92808	#92811
Mixed	#92804	#92806	#92809

Color	2 1/8" (10M) 15 Per Bag	2 3/4" (10M) 15 Per Bag	3 1/4" (7.5M) 15 Per Bag
White	#92815	#92915	#92920
Mixed	#92816	#92916	#92921
Natural	#92817	#92917	#92922

▶ **PRO SHOP PACKAGING**

- #92875 - 2 1/8" ShorTee - 25 per bag
  - #92876 - 2 3/4" ProLength - 20 per bag
  - #92877 - 3 1/4" ProLength-Plus - 15 per bag
  - #92878 - 4" Prolength-Max - 12 per bag
- 200 bags per carton

▶ **RETAIL PACKAGING**

- #92883 - 2 1/8" ShorTee - 120 per bag
  - #92884 - 2 3/4" ProLength - 100 per bag
  - #92885 - 3 1/4" ProLength-Plus - 75 per bag
  - #92886 - 4" Prolength-Max - 50 per bag
- 12 bags per carton

▶ **PERSONALIZED TEES**

Please specify tee color and imprint color when ordering.

- |                     |                      |                      |
|---------------------|----------------------|----------------------|
| #92500 - 2 1/8" Tee | #92501 - 2 3/4", Tee | #92502 - 3 1/4", Tee |
| 1-2 M               | 1-2 M                | 1-2 M                |
| 3-4 M               | 3-4 M                | 3-4 M                |
| 5-9 M               | 5-9 M                | 5-9 M                |
| 10-49 M             | 10-49 M              | 10-49 M              |
| 50 M or More        | 50 M or More         | 50 M or More         |

1-5 Lines and logo'd tees

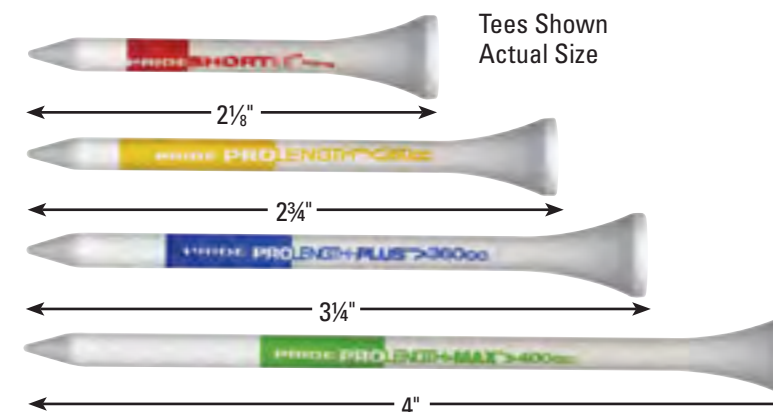

Chat with specialists @ [www.wittekgolf.com](http://www.wittekgolf.com)



## DIVOT REPAIR TOOLS



### CUSTOM EMBOSSED DIVOT REPAIR TOOL

Plain tools are also available.  
Imprint area: 1 1/8" x 1/2"  
Minimum quantity: 1,000

- #91290 - Gold
- #91291 - Silver
- #91292 - Pewter
- #91293 - Antique Brass
- #91294 - Antique Copper

## BALL MARKERS



### PLASTIC BALL MARKERS & QUARTERMARKS®

Molded from high impact plastic.  
Sold in quantities of 1,000.  
Plain - Assorted or neon color only.  
Personalized - Specify color of marker and color of imprint.

- #91266 Plain Dime Markers
- #91267 Personalized Dime Markers
- #91268 Plain QuarterMarks
- #91269 Personalized QuarterMarks



### FLIX DIVOT REPAIR TOOLS

Switchblade action and a soft feel finish along with stainless steel forks sets this Divot tool apart from the competition. The Flix Lite comes with a magnetic ball marker that can be customized with a full color resin domed logo. The Flix Lite DS features two unique branding locations. Free custom display with an order of 50 pcs and no artwork setup charge for either tools! Colors for Flix Lite: Lime Green, Red, Blue, Orange, Black. Flix Lite DS colors: Blue, Black, Red, White.

- #FXLT - Flix Lite w/ Custom Logo Marker
- #FXDS - Flix Lite DS w/ Custom Logo on back and Marker



### DELUXE REPAIR TOOL

Our premium divot repair tools are available in 25 vibrant colors, including neon. Please specify when ordering.

- #91250 - Plain - Assorted or specific color only
- #91251 - Personalized - Assorted or specific color only

## BAG & CART TAGS

Made of unbreakable plastic, Bag and Cart Tags can be customized with your course name and logo or personalized for any event.



#93301  
Rectangle Bag Tag



#93302  
Square Bag Tag



#93303  
Diamond Bag Tag



#93304  
Jumbo Tag



#93305  
Guest Bag Tag



#93307  
Round Bag Tag



#93308  
Oval Bag Tag



#93310  
Cart Tag

## REPLACEMENT CLEATS

### CLEATKADDY® AND DRILL BITS

Now it's more convenient than ever before to install alternative golf cleats. Made of rugged reinforced plastic.  
#93997 - \$8.99 ea.



### MULTI WRENCH KIT

In the past worn cleats have been difficult to remove, but thanks to Softspikes Cleat Ripper cleat changing is now easier than ever. Tune-up your game by changing your cleats.  
#93996 - \$5.99 ea.



Product Description	fast twist 3.0 Insert System	PINS
Kits	#92455	#92470
400ct Bowl	#92465	#92472



Product Description	fast twist 3.0 Insert System	QFIT SYSTEM	PINS
Kits	#92310	#92315	#92320
400ct Bowl	#92334	#92335	#92321

Reorder easily @ [www.wittekgolf.com](http://www.wittekgolf.com)



## REPAIR ACCESSORIES & TOOLS

### ▶ ALL-AMERICAN JUNIOR SETS SL500 CLUBS

Featuring oversized titanium alloy woods and die cast perimeter flow weighted oversized irons with steel shafts.

#### JUNIOR 5 PIECE SETS

Includes #1 Wood, #5 Hybrid, 7, 9 Iron and Putter. Weight: 6 lbs.

#95115 - Right Hand

#95116 - Left Hand

#### JUNIOR 7 PIECE SETS

Includes #1 Wood, #3 Wood, #5 Hybrid, 7, 9 Iron Sand Wedge and Putter. Weight: 8 lbs.

#95117 - Right Hand

#95118 - Left Hand

Club	(RH)	(LH)
#1 Wood	#95525	#95625
#3 Wood	#95526	#95626
Hybrid	#21205D	#51805D
#5 Iron	#95530	#95630
#7 Iron	#95532	#95632
#9 Iron	#95534	#95634



### ▶ RITE ON WEDGES

These wedges were especially designed for versatility whether you're playing from grass, rough, or sand. Weight: 1 lb.

#95836 - 52° A Wedge - Right Handed

#95837 - 56° Sand Wedge - Right Handed

#95838 - 60° Lob Wedge - Right Handed

Please Call For Left Handed



#95836



#95837



#95838



### ▶ HOOK BLADE KNIFE

#90763 - Hook Blade Knife .

#90764 - Replacement Blade (5 pack)



### ▶ GO-GETTER BALL RETRIEVERS

Popular hinged cup design. Extends to 12' length.

#93830



### ▶ REGRIPPING TAPE

A must for all regrippers!

#90725 - Lead Tape - 3/4" x 45"

#90730 - Two Way Tape - 3/4" x 108'

#90735 - Two Way Tape - 1" x 108'

#90740 - Two Way Tape - 2" x 108'

### ▶ SL500 CLUBS - TITANIUM ALLOY WOODS & ZINC ALLOY IRONS.

Flow weighting system combines perimeter weighting with peripheral weighting to insure that each club head is weighted optimally for its specific purpose. Right and Left Hand available. Set includes 2 Woods (1 & 3), 1 Hybrid (#3/4), 6 Irons (5-9, PW) and Putter. Weight: 12 lbs.

#95253 - Men's Right Hand #95255 - Women's Right Hand

#95254 - Men's Left Hand #95256 - Women's Left Hand

Club	Men's (RH)	Men's (LH)	Women's (RH)	Women's (LH)
#1 Wood	#95125	#95225	#95325	#95425
#3 Wood	#95126	#95226	#95326	#95426
Hybrid	#51034D	#81034D	#61034D	#91034D
#3 Iron	#95128	#95228	#95328	#95428
#5 Iron	#95130	#95230	#95330	#95430
#6 Iron	#95131	#95231	#95331	#95431
#7 Iron	#95132	#95232	#95332	#95432
#8 Iron	#95133	#95233	#95333	#95433
#9 Iron	#95134	#95234	#95334	#95434
#PW	#95135	#95235	#95335	#95435

### ▶ SHOT CONTROL PUTTERS

These stainless steel putters feature great sight lines for alignment. Available in four head designs. One left hand style available. 34" steel shaft. Weight: 1 lb.



#95915

#95916

#95917

#95918

#95919

Left Hand

### ▶ HF-100 ADVANCE GRIP TAPE ACTIVATOR

"The Grip Solution" works with any double sided grip tape. It is non-toxic, non-flammable, odorless, reusable, and easy to clean up. It greatly reduces the amount of solution used by 60%. Playable in 10-15 minutes. Available in quarts or gallons. Spray pump sold separately.

#90750 - Quart

#90752 - Gallon

#90751 - Pump Spray for quart



### ▶ GRIP REMOVER GUN WITH NEEDLE & ADAPTER

#90483 .



### ▶ GRIP REMOVER NEEDLES

Pack of 12

#90773

## RENTAL CLUBS





# GOLF GRIPS

## ▶ EXCEL SOFTGRIP



## ▶ DRI-TAC GRIP

WinnDry Technology



## ▶ TOUR SNSR PUTTER GRIP



Code	Color	Size	Core	Weight
#90379	Black	Standard	.600 (Rnd)	42g
#90382	Black	Oversize	.600 (Rnd)	47g

Code	Color	Size	Core	Weight
#90675	Pink/Gray	Undersize	.590 (Rnd)	35g
#90585	Gray	Undersize	.590 (Rnd)	35g
#90586	Dark Gray	Standard	.600 (Rnd)	48g
#90588	Dark Gray	Midsize	.600 (Rnd)	49g
#90116	Navy Blue	Midsize	.600 (Rnd)	49g
#90589	Black/Blue	Midsize	.600 (Rnd)	49g
#90590	Dark Gray	Oversize	.590 (Rnd)	50g

Code	Size/Color
#GPPC1L	Golf Pride Tour SNSR *CONTOUR* (140CC)-Large
#GPPC1M	Golf Pride Tour SNSR *CONTOUR* (140CC)-Small
#GPP1L	Golf Pride Tour SNSR *CONTOUR PRO* (140CC)-Large
#GPP1M	Golf Pride Tour SNSR *CONTOUR PRO* (140CC)-Small
#GPPS1L	Golf Pride Tour SNSR *STRAIGHT* (140CC)-Large
#GPPS1M	Golf Pride Tour SNSR *STRAIGHT* (140CC)-Small

## ▶ SUPERSTROKE GRIPS

The SuperStroke putter grip series are widely popular among golfers. The no-taper technology has helped millions of golfers achieve a more consistent stroke. Available in a variety of sizes & colors!

Code	Color	Size	Core	Weight
#90325	Black/White Logo	Standard	.580 (Rnd)	51.5g
#90324	Black/White Logo	Standard	.580 (Rib)	51.5g
#90327	Black/White Logo	Standard	.600 (Rnd)	49.5g
#90326	Black/White Logo	Standard	.600 (Rib)	49.5g
#90329	Black/White Logo	Midsize	.600 (Rnd)	53.5g
#90330	Black/White Logo	Jumbo	.600 (Rnd)	61g

Code	Color	Size	Core	Weight
#90488	Black/White Logo	Standard	.580 (Rnd)	50g
#90489	Black/White Logo	Standard	.600 (Rnd)	48g
#90490	Black/White Logo	Midsize	.600 (Rnd)	58g
#90491	Black/White Logo	Jumbo	.600 (Rnd)	73g
#90492	White/Black Logo	Standard	.600 (Rnd)	55g

Code	Color	Size	Core	Weight
#90300	Red/Black	Standard	.600 (Rnd)	46.5g
#90301	White/Black	Standard	.600 (Rnd)	46.5g
#90303	Blue/Black	Standard	.600 (Rnd)	46.5g
#90302	Yellow/Black	Standard	.600 (Rnd)	46.5g
#90652	Black/Black	Standard	.600 (Rnd)	46.5g

Code	Color	Size	Core	Weight
#90001	Black/Blue	Standard	.600 (Rnd)	52g
#90002	Black/Red	Standard	.600 (Rnd)	52g
#90003	Black/Grey	Standard	.600 (Rnd)	52g
#90004	Black/Grey	Midsize	.600 (Rnd)	66g

Code	Color	Size	Core	Weight
#90109	Black/Blue	Standard	.600 (Rnd)	51g
#90110	Black/Blue	Midsize	.600 (Rnd)	64g
#90106	Black/Red	Standard	.600 (Rnd)	51g
#90107	Black/Red	Midsize	.600 (Rnd)	64g

Code	Color	Size	Core	Weight
#90383	Black/White	Standard	.600 (Rib)	51g
#90384	Black/White	Midsize	.600 (Rib)	62g

Code	Color	Size	Core	Weight
#90178	Black/Red	Standard	.600 (Rib)	51g

# GRIPS BY GOLF PRIDE

## ▶ TOUR VELVET STYLES GRIP

Buffed Rubber



#90321

## ▶ TOUR WRAP 2G GRIP

Rubber Seamless

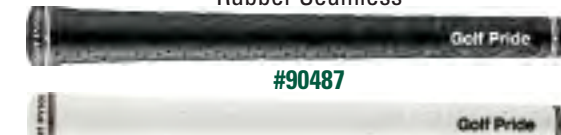

#90487

## ▶ MULTI-COMPOUND GRIP

Cord Rubber



#90300

#90301

#90302

#90303

## ▶ MCC PLUS 4 GRIP

Cord Rubber



#90003

#90002

#90001

## ▶ CP 2



Pro

Wrap

## ▶ MCC ALIGN



## ▶ TOUR VELVET ALIGN





# MINIATURE PUTTERS

## ▶ BLACK LIGHT PUTTERS

Add cool colors to your Black Light course. Urethane heads are combined with a matching grip to complete the putter.

- Glows under Black Light.
- Four colors to choose from.

Available in 37", 35", 31" and 27". Custom lengths available.

Colors: Orange, Yellow, Pink, and Green.

Weight: 1 lb.



Color	37"	35"	33"	31"	29"	27"
Orange	#83837	#83835	#83833	#83831	#83829	#83827
Yellow	#83937	#83935	#83933	#83931	#83929	#83927
Pink	#84137	#84135	#84133	#84131	#84129	#84127
Green	#84037	#84035	#84033	#84031	#84029	#84027

## ▶ TRADITIONAL PUTTERS

Our chrome and silver satin putters offer long life and a classic design.

- Double sided putter heads for right and left handed players.
- Made of durable die cast heads with extra thick hosel walls.
- Stainless steel step-down shafts.
- Custom designed grips with molded plastic butt cap for longer wear.
- Weight: 1 lb.

Model	37"	35"	33"	31"	29"	27"
<b>(A)</b> Chrome End Shaft	#81137	#81135	#81133	#81131	#81129	#81127
<b>(B)</b> Silver Satin	#81237	#81235	#81233	#81231	#81229	#81227
<b>(C)</b> Chrome Center Shaft	#81437	#81435	#81433	#81431	#81429	#81427

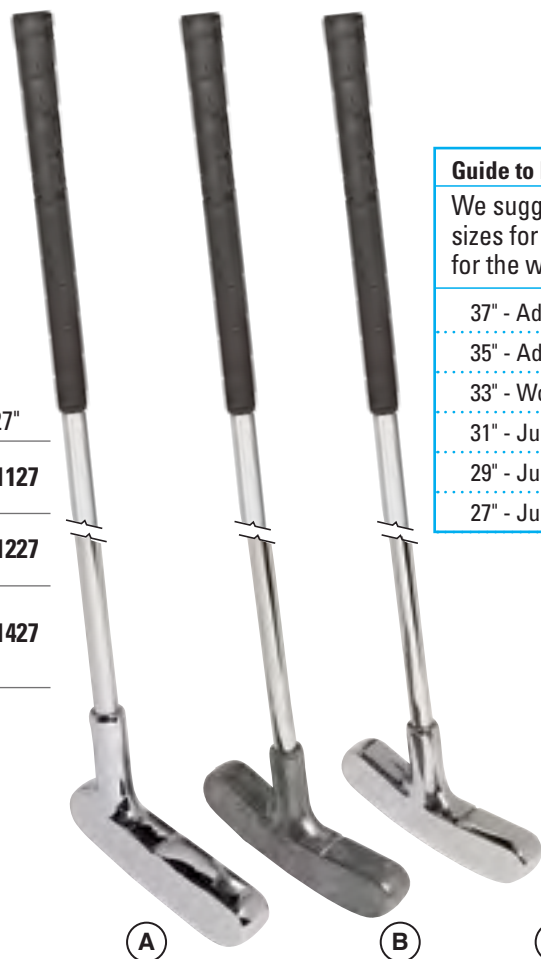

### Guide to Putter Selection

We suggest the following sizes for ordering putters for the whole family:

- 37" - Adult Men & Women (6'+)
- 35" - Adult
- 33" - Women/Teens +
- 31" - Junior (Age 10-12)
- 29" - Junior (Age 7-9)
- 27" - Junior (Age 5-7)

Call for other sizes and custom grip/head combinations.

## ▶ SAFE-T PUTTERS

The popular putters that everyone loves! Softer head reduces the damage to fairway carpet, landscaping, and obstacles.

Weight: 1 lb.

- The most durable putters on the market.
- They pay for themselves in terms of preventing injury to players.
- Enjoy insurance premium reductions with the use of Safe-T Putters throughout your course.
- Designed of "soft touch" Nitrile rubber molded around entire blade.
- Specially weighted to industry standards.
- Available in 37", 35", 31" and 27".
- Sizes from Kids to Adults.



Color	37"	35"	33"	31"	29"	27"
Orange	#81737	#81735	#81733	#81731	#81729	#81727
Purple	#81537	#81535	#81533	#81531	#81529	#81527
Blue	#82337	#82335	#82333	#82331	#82329	#82327
Green	#82037	#82035	#82033	#82031	#82029	#82027
Yellow	#81637	#81635	#81633	#81631	#81629	#81627
Pink	#81837	#81835	#81833	#81831	#81829	#81827
Black	#82537	#82535	#82533	#82531	#82529	#82527
Red	#81937	#81935	#81933	#81931	#81929	#81927

## ▶ URETHANE PUTTERS

This stylish Urethane Putter is the newest addition to the Wittek putter line.

Weight: 1 lb.

- Durable yet still softer than metal putters.
- Bull's eye and aiming line on the head.
- Available in 8 exciting colors.
- Sizes from Kids to Adults.
- Available in 37", 35", 31" and 27" Weight: 1 lb.



Color	37"	35"	33"	31"	29"	27"
Orange	#83337	#83335	#83333	#83331	#83329	#83327
Purple	#83537	#83535	#83533	#83531	#83529	#83527
Blue	#83137	#83135	#83133	#83131	#83129	#83127
Green	#83237	#83235	#83233	#83231	#83229	#83227
Yellow	#83737	#83735	#83733	#83731	#83729	#83727
Pink	#83437	#83435	#83433	#83431	#83429	#83427
Black	#83037	#83035	#83033	#83031	#83029	#83027
Red	#83637	#83635	#83633	#83631	#83629	#83627

Order online 24/7 @ [www.wittek golf.com](http://www.wittek golf.com)



# MINIATURE GOLF BALLS

## 2-PIECE MINIATURE BALLS

Wittek offers the widest selection of quality Miniature Golf Balls in the industry... neons, pastels and originals in a rainbow of fun colors! Featuring Surlyn covered, two piece construction. Sold in dozens. Shipping Weight: Golf balls weigh 1lb./dozen.

	Original 2-Piece Solid Color Balls	Floater Solid Color Balls
Blue	#82115	#82215
Green	#82116	#82216
Orange	#82117	#82217
Red	#82118	#82218
Yellow	#82119	#82219
Black	#82133	#82233
Purple	#82134	#82234
Neon Green	#82121	#82221
Neon Orange	#82122	#82222
Neon Pink	#82123	#82223
Neon Yellow	#82124	#82224
Pastel Blue	#82126	#82226
Pastel Green	#82127	#82227
Pastel Pink	#82129	#82229
Pastel Lavender	#82130	#82230
White	#82135	

## FLOATER MINIATURE BALLS

We're not kidding when we say our balls rise to the top over the others, after all, they're Floater Balls! Our unsinkable favorites are available in every color. Sold in dozens. Shipping Weight: Golf balls weigh 1 lb./dozen.



# NOVELTY GOLF BALLS

## EMOJI BALLS

Sold as a set. #82196  
Shipping Weight: Golf balls weigh 1 lb./Dz.



## BLACK LIGHT BALLS

Add more colors to your Black Light course. Glows under Black Light. Five colors to choose from. Colors: Green, Orange, Pink, Yellow, and White. Weight: 1 lb./Dz.

Neon Green	#82121
Neon Orange	#82122
Neon Pink	#82123
Neon Yellow	#82124
White	#82125



## GALACTIC NOVELTY BALLS

Sold as a set. Shipping Weight: Golf balls weigh 1 lb./Dz. #82197



## 2-PIECE NOVELTY MINIATURE BALLS

Shipping Weight: Golf balls weigh 1lb./Dz.





## ACCESSORIES

### ▶ REPLACEMENT GRIPS

Specially designed for commercial use. Grips feature a custom designed butt cap made of durable plastic molded to the grip. A metal washer is molded into every cap for added strength.

#83100 - Black #83425 - Orange  
 #83200 - Blue #83450 - Purple  
 #83300 - Red #83475 - Pink  
 #83400 - Green #83500 - Yellow



2 metal washers are in the end of the putter shaft/grip. One is molded into the cap, the other is placed on the shaft end for added strength and durability. This withstands the abuse or constant tapping and pounding.



### ▶ JUNIOR PUTTERS IN PLASTIC

Lightweight design is ideal for small children.

- Made of solid polyethylene.
  - Double sided putter head, for right and left handed players.
- Colors: Green, Red, Blue. 19" long.

#81150 - Green  
 #81151 - Red  
 #81152 - Blue

### ▶ KIDS PUTTER HOLDER

16"W x 16"D x 16"H.  
 Holds 64 putters.  
 Weight: 13 lbs.  
 #81175 - Black  
 #81176 - Green



### ▶ ADULT PUTTER HOLDER

14"W x 14"D x 31"H.  
 Holds 64 putters.  
 Weight: 17 lbs.  
 #81180 - Black  
 #81181 - Green



### ▶ RECYCLED PLASTIC PUTTER RACK

This super sturdy putter rack is made from recycled plastic and is virtually maintenance free! Store your putters in style with a rack that will last forever!

#J300BLK - Black  
 #J300BRN - Brown  
 #J300GRN - Green  
 #J300DRT - Driftwood  
 #J300WN - Walnut  
 #J300C - Custom



### ▶ PENCIL BOX



An attractive and durable way to store & display your pencils on the counter! Holds up to 144 pencils. 3"H x 5"W x 6"D (4 lbs.)  
 #P300BLK - Black  
 #P300BRN - Brown  
 #P300GRN - Green  
 #P300DRT - Driftwood  
 #P300WN - Walnut  
 #P300C - Custom



### ▶ PENCILS

Our Hex pencils are the standard of the industry. 8 available colors. 3½" long. Sold per gross (144 pencils). Weight: ¾ lb./gross.

#84115 - Black #84316 - Yellow  
 #84116 - Green #84119 - Cranberry  
 #84118 - Blue #84120 - Natural  
 #84216 - Red #84121 - White



### ▶ GOLF BALL COUNTER DISPLAY

A clever and convenient way to display your miniature golf balls! White golf ball is made of high density polyethylene and sits on a 12" wide metal base. Holds up to 12 dozen balls. 12" dia. x 12"H Weight: 3 lbs. Golf balls not included.  
 #64695 - Counter Display

New Design



### ▶ MINIATURE GOLF SCORECARDS

Made of heavy card stock paper. Cards are scored in the center for easy folding. Sold 1000/package. 4" W x 8.5"L Weight: 7 lbs.  
 #84114 - Scorecards



### ▶ PERSONALIZED HEX PENCILS

A great way to advertise your miniature golf course or family fun center! Up to 3 lines of print. 8 available colors. Engraving Colors: Black, White, Metallic Gold, Silver, Blue, Green, Red. Specify when ordering. Allow 2 weeks for delivery. 3½" long. Sold per gross (144 pencils). Weight: ¾ lb./gross. 10 Gross minimum. 20+ Gross order - No set up charge. 10 Gross order - \$10.00 set up fee.

#84150 - Black #84170 - Red #84153 - Natural  
 #84160 - Green #84180 - Yellow #84154 - White  
 #84151 - Blue #84152 - Cranberry



### ▶ MINIATURE GOLF BALL VENDOR

Ideal for countertops or hanging on a wall. Durable yellow coating for long lasting wear. Ten columns hold a total of 110 golf balls. 10½" W x 19"H x 5"D. Weight: 4 lbs. Golf balls not included.  
 #84500 - Ball Vendor



# CARPETING



### ▶ WITTEK QUICK PUTT CARPET

- Outdoor carpet has truest roll of the balls
- 12' wide sold per square yard
- Fiber Type: 100% High UV Olefin
- Color: Green
- Pile Height: 3/16"
- Face Weight: 22 oz.
- Backing: Action Back
- Stimp reading: 8-10

#86303

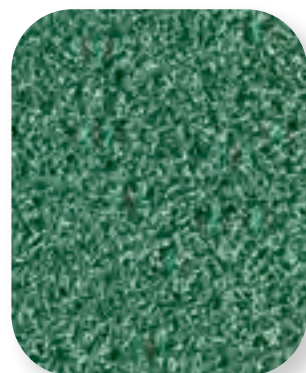

### ▶ WITTEK CHOICE PUTTING CARPET

- Outdoor carpet for heavy foot traffic.
- 12' wide sold per square yard
- Face Yarn: 8/4400 Denier Textured
- Polypropylene
- Color: Ivy League
- Pile Height: 7/16"
- Pile Weight: 26 oz.
- Stitch Rate: 18
- Primary Backing: Black UV
- Secondary Backing: action Back/Unitary
- Limited 8 Year Warranty
- Stimp reading: 14

#86307

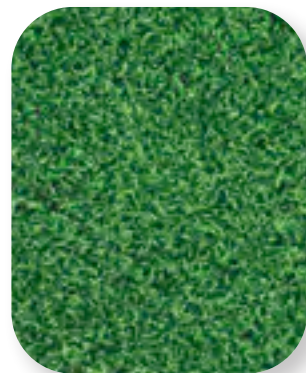

### ▶ WITTEK "EAGLE" PUTTING CARPET

- Outdoor carpet for heavy foot traffic. Easier to clean with course with a lot of trees and foliage.
- 12' wide sold per square yard
- Face Yarn: 5600/8 Denier Nylon
- Color: Lawn Green
- Pile Height: 1/2"
- Pile Weight: 28 oz.
- Backing: Action Back
- Limited 8 Year Warranty
- Stimp reading: 10

#86308

### ▶ TEE OFF PADS

Our durable pads are designed for high volume commercial use. For right and left handed players.

### ▶ NEW COLORED GRASS TEE OFF PADS

Raised holes make it easier for kids to play. 12"x 12". Available in 6 colors.

Weight: 0.80 lb.

- #84403 - Blue
- #84404 - Green
- #84405 - Orange
- #84406 - Red
- #84407 - Yellow
- #84408 - Black

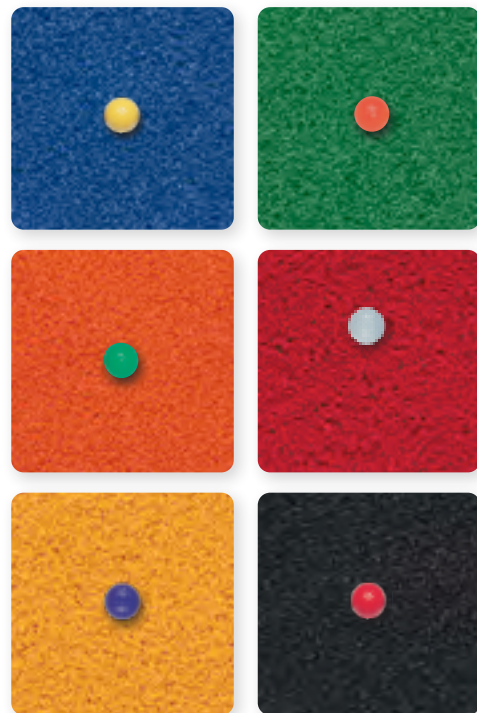

### ▶ RUBBER

Our heavy duty rubber pads will last season after season. Weather resistant. Available in two sizes.

- #84401 - Rubber Tee Off Pad. 11½"W x 11½"L x 1/8" thick. Weight: 1 lb.
- #84402 - Jumbo Rubber Tee Off Pad. 36"W x 24"L x 1/8" thick. Weight: 6 ½ lbs.



# SIGNS & HOLDERS

### ▶ LAMINATED PLASTIC TEE SIGNS

Make sure your mini golfers know where they're going, and make your mini golf course stand out with our 100% custom, laminated plastic tee signs made specifically for mini golf! Give us a call and we can put together a package specific to you and your course, with informational signs, hole layout signs, and mounting options that best fit your course!



### ▶ PRO 2000 SIGN/CLOCK HOLDERS

A clock or sign on both sides will keep your golfers informed and on time! Built in handle allows for easy movement. Sign holders are sold double sided without signs included. Clock holders are sold double sided including 2, outdoor/all-weather clocks that run on one AA battery (not included).

Size: 18½"W x 29"H. Weight: 16 lbs.

- #77325 - Black Pro 2000 Starter clock (clock on both sides)
- #77327 - Green Pro 2000 Starter clock (clock on both sides)
- #77285 - Black Pro 2000 Sign Holder Clock Only (Double Sided/signs sold separate)
- #77286 - Green Pro 2000 Sign Holder Clock Only (Double Sided/signs sold separate).
- #77322 - 12" Clock Only



### ▶ INDIVIDUAL MINI GOLF SIGNS

Nine different popular signs. All signs are single sided and made from durable styrene. Order sign holder separately. Size: 14½"W x 13"H. Weight: .40 lb.



#81190



#81191



#81192



#81193



#81194



#81195



#81196



#81197



#81198



## PICKERS

## Range Rover

## Draw Bar Parts List

#71770	Coupler for Front Section
#71776	Coupler Repair Kit to fit 2" Ball
#71798	Ball Hitch 2" Diameter
#71854	Range Rover Draw Bar
#71936	Swivel/Caster Fork
#71937	Axle for Front Wheel
#71946	12" Long Post Assembly
#71950	Front Wheel Sealed Bearings
#71969	Range Rover Push Bar
#71976	Vehicle Attachment Bar
#71981	7-1/4" Connecting Rod
#71985	5-15/16" Post Assembly Rod
#71989	Wheel/Tire with Bearings

## Drum Section Parts List

#71801	3/4" Pillow Block Bearing
#71805	3/4" Axle for 3-5 Gang Drum
#71808	Drum Section Tire
#71857	Range Rover Front Frame
#71912	Plastic Picker Basket
#71912S	Stackable Picker Basket
#71916	Drum Section End Plate
#71919	3/8" Tie Rod
#71920	3' Black Drum Section (with end tires)
#71920W	3' White Drum Section (with end tires)
#71932	Disc Only - Black
#71932W	Disc Only - White
#71939	Range Rover Side Frames
#71959	Drum Section End Spacer
#71978	Wheel Only for Drum Section
#71984	Retaining Pin

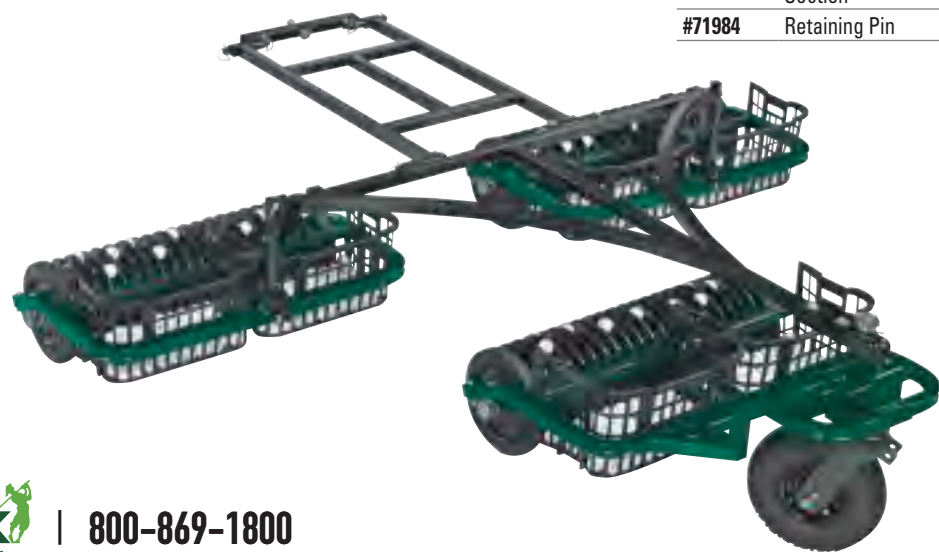

## 2000 To Current SL90

## Draw Bar Parts List

#71715	Small Swivel & Caster Fork
#71725	Small Front Wheel, Tire, Tube, and Axle
#71790	Axle for Small Front Wheel
#71794	Bearings for 2000 Small Front Wheel
#71813	Right SL90 Outrigger Bar Only
#71814	Left SL90 Outrigger Bar Only
#71815	SL90 Junior Draw Bar Only
#71816	SL90 Senior Draw Bar Only
#71817	SL90 Deflector with Square Rod
#71817R	SL90 Deflector with Round Rod
#71936	SL90 Swivel Caster Fork
#71937	SL90 Axle for Front Wheel
#71967	3/4" SL90/BH Bearing
#71989	Front Wheel/Tire with Bearings

## Drum Section Parts List

#71801	3/4" Pillow Block Bearing
#71805	3/4" Axle for 3-5 Gang
#71808	Drum Section Tire
#71821	SL90 Frame Only
#71912	Plastic Picker Basket
#71912S	Stackable Picker Basket
#71916	Drum Section End Plate
#71919	Tie Rod 3/8"
#71920	3' Black Drum Section (with end tires)
#71920W	3' White Drum Section (with end tires)
#71959	Drum Section End Spacer
#71932	Disc Only - Black
#71932W	Disc Only - White
#71978	Wheel Only for Drum Section
#71984	Retaining Pin

## 2000 To Current Ball Hawk

## Draw Bar Parts List

#71715	Single Section Swivel & Caster Fork (5ft.)
#71725	Small Front Wheel, Complete
#71790	Axle for Small Front Wheel (5ft.)
#71794	Small Front Wheel Bearing (5ft.)
#71940	Articulating Elbow
#71941	7-1/2" Front Wheel Axle
#71946	12" Long Post Assembly for 3-5 Gang
#71950	Front Wheel Sealed Bearings
#71967	3/4" SL90/B.H. Bearing
#71968A	Ball Hawk Draw Bar
#71969	Ball Hawk Push Bar
#71976	Ball Hawk Vehicle Attachment Bar
#71979	Ball Hawk Caster Fork Complete
#71981	7-1/4" Connection Rod
#71985	5-1/2" Extension Rod Only
#71989	Wheel/Tire with Bearing for 3-5 Gang

## Drum Section Parts List

#71801	3/4" Pillow Block Bearing
#71805	3/4" Axle for 3-5 Gang
#71808	Drum Section Tire
#71912	Plastic Picker Basket
#71912S	Stackable Picker Basket
#71916	Drum Section End Plate
#71919	Tie Rod 3/8"
#71920	3' Black Drum Section (with end tires)
#71920W	3' White Drum Section (with end tires)
#71932	Disc Only - Black
#71932W	Disc Only - White
#71939	3-5 Gang Frame Only
#71959	Drum Section End Spacer
#71978	Wheel Only for Drum Section
#71984	Retaining Pin

## Commercial Tire Picker

#71710	Large Swivel & Caster Fork for Super, Senior or Junior Pickers
#71715	Small Swivel & Caster Fork for Single unit Picker
#71720	Large Front Wheel, Tubeless Tire and Axle for Super, Senior or Junior Picker
#71725	Small Front Wheel, Tire, Tube and Axle for Single Unit Picker and Outrigger Bar
#71801	Pillow Block Bearings 3/4"
#71804	Tie Rods 3/8"
#71806	Spacers
#71822	Wittek Picker Axel
#71978	Wheel Only for Drum Section
#71809	Wheels and Tires Complete, Disc Shape 3/4" Axle Opening
#71810	Wittek Tire Picker End Wheel
#71811	Wittek Tire Picker Drum Section
#71818	Commercial Tire Wire Basket

## PICKERS

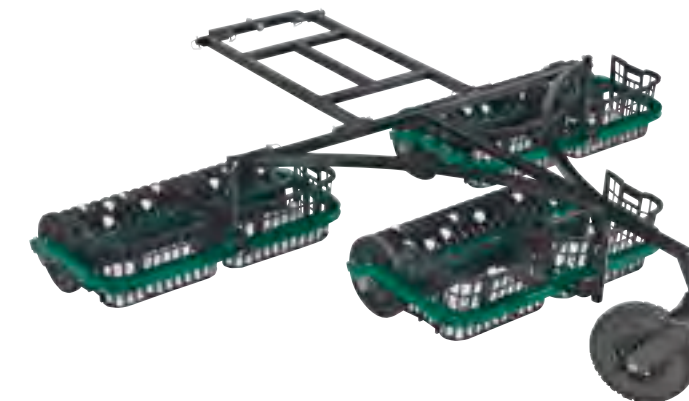

## Eagle Lite

#71922	Black Drum Set (includes axle bracket set)
#71923	White Drum Set (includes axle bracket set)
#WGRM036	Disc Only - Black
#WGRM037	Disc Only - White
#71760	Adjustable Drum Brackets (set)
#71762	Back Post Assembly
#71763	Front Wheel Package
#71940	Articulating Elbow
#71946	12" Long Post Assembly for 3-5 Gang
#71950	Front Wheel Sealed Bearings
#71968A	Ball Hawk Draw Bar
#71969	Ball Hawk Push Bar
#71976	Ball Hawk Vehicle Attachment Bar
#71979	Ball Hawk Caster Fork Complete
#71981	7-1/4" Connection Rod
#71985	5-1/2" Extension Rod Only
#71989	Wheel/Tire with Bearing for 3-5 Gang

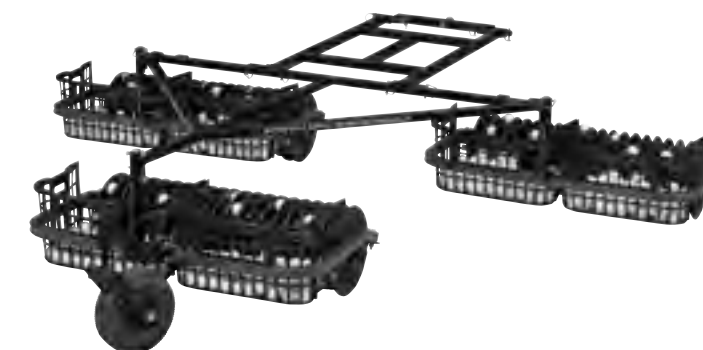
Use your terms @ [www.wittekgolf.com](http://www.wittekgolf.com)



## DISPENSERS



## 2002 To Current Signature Ball Dispenser

#74126	Replacement Key #4657
#74128	Replacement Key #7311
#74223	Drop Coin Mechanism
#74233	Bill Acceptor Only
#74234	Actuator Arm
#74241	Control Box
#74242	Actuator Cable
#74243	Accumulator Board



## Wittek Elite Series Ball Dispenser

#74759-1	Motor/Gearhead
#74759-2	Plastic Block with Shafts
#74759-3	Dispenser Shaft Assembly
#74759-4	Ball Tray Assembly
#74759-5	Bearings for 1" Shafts
#74759-6	Dispenser Shaft Fingers
#74759-7	Keypad Door Panel
#74759-8	Timer Relay & Socket for Coin Mechanism
#74759-9	Belt
#74759-10	Rubber Door Bumper
#74759-11	Bill Acceptor
#74223	Drop Coin Mechanism
#74128	Replacement Key #7311
#74130	Replacement Key #
#74759-80	GFCI Outlet

## 50G Superwash

#73179	Vibrator Motor With Mounting Bracket
#73178-SD	Square D Starter Switch w/ Thermal Unit
#73186	Drive Coupling
#73193	Wire Hopper
#73373	1/2 H.P. Motor with Switch Coil
#73374	1/2 H.P. Motor, No Switch
#73566	50G Rubber Strip Set
#73571	Wheel for Dolly
#73577	Washer Bearing Only
#73578	Washer Bearing with Housing
#73580	Guide Set Only (No Strips)
#73581	Quick Release Pin Only
#73611	50G Brush Drum
#74759-80	GFCI Outlet
#7219K22	GFCI Outlet Box
#7219K62	GFCI Outlet Cover
#M-73-43	50G Rubber Latch



## WASHERS



## WITTEK TWIST

#P2BW10	Spiral
#P2BW06	Bearings
#P2BW09	Brush
#P2BW04	LG Pulley
#P2BW03	V-Belt
#P2BW15	Belt Guard
#P2BW05	Small Pulley
#P2BW01	Motor
#P2BWR01	Legs
#P2BW08	Brush Shaft
#P2BW11	Top
#P2BW12	Grate
#P2BW02	Switch
#P2BW14	Cover
#P2BW18	Wheel Kit
#P2BWGFI	Replacement GFI Plug



## 50G Junior

#73179	Vibrator Motor With Mounting Bracket
#73175-SD	Square D Starter Switch w/ Thermal Unit
#73186	Drive Coupling
#73193	Wire Hopper
#73173	1/4 H.P. Motor with Switch Coil
#73174	1/4 H.P. Motor, No Switch
#73587	50G Jr. Rubber Strip Set
#73571	Wheel for Dolly
#73577	Washer Bearing Only
#73578	Washer Bearing with Housing
#73655	Guide Set Only(no strips)
#73581	Quick Release Pin Only
#73651	50G Jr. Nylon Brush Drum
#74759-80	GFCI Outlet
#7219K22	GFCI Outlet Box
#7219K62	GFCI Outlet Cover
#M-77-56	50G Jr Rubber Latch

GO TO [WITTEKGOLF.COM/MANUALS](http://WITTEKGOLF.COM/MANUALS) FOR MANUALS AND PRODUCT REPAIR GUIDES

## TERMS &amp; CONDITIONS

## Satisfaction

Your 100% satisfaction is our goal. Please notify us promptly should any product not meet your expectations.

## Pricing

Prices are subject to change. On occasion, circumstances that are out of our control could result in price changes. Wittek Golf will always try to maintain and honor published pricing. All prices are F.O.B. shipping point.

## Damage or Discrepancy

It is the customer's responsibility to notify carrier of any damage or discrepancy immediately. Once a bill of lading is signed the customer bears all liability for accuracy and quantity of all products. Any concealed damage must be reported to carrier immediately and to Wittek Golf within 5 business days.

## Warranty

Items manufactured by Wittek Golf carry a one year warranty. Warranties on non-Wittek products vary by manufacturer. Associates are not authorized to give additional warranties without written permission.

## Returns

No product may be returned without an approved Return Goods Authorization Number (RGA). RGA request must be made within 30 days of purchase. All returns must be unused and resellable. Credit cannot be issued for damaged or obsolete products. In most cases, Custom or Special Order products are not returnable. All returns are subject to a 15% restocking fee. Return freight charges may apply.

## Credit Terms

Customers may receive commercial credit terms with approved credit applications. Full payment is expected on due dates. A service charge of 1.5% per month may be imposed on delinquent balances. Other forms of accepted payment include Visa, MasterCard, Amex, Discover, cashier's check, money order or wire transfer.

See your invoices/statements @ [www.wittek golf.com](http://www.wittek golf.com)



Wittek Golf  
300 Bond St.  
Elk Grove Village, IL 60007  
www.wittekgolf.com

Since 1946

# WITTEK



## Golf Supply Specialists



Order Online at  
[wittekgolf.com](http://wittekgolf.com)

Hours: 7:00am - 7:00pm CST  
p: 800.869.1800 · f: 847.412.9591  
[wittekgolf.com](http://wittekgolf.com) · [info@wittekgolf.com](mailto:info@wittekgolf.com)

300 Bond St.  
Elk Grove Village, IL 60007  
[www.wittekgolf.com](http://www.wittekgolf.com)

4785 E. Bryson St.  
Anaheim, CA 92807  
[www.wittekgolf.com](http://www.wittekgolf.com)